



OPERATING INSTRUCTIONS



Translation of the original instructions

ASI 35

Modular leak detector

Table of contents

1	About this manual	5
1.1	Validity	5
1.1.1	Applicable documents	5
1.2	Conventions	6
1.2.1	Safety instructions	6
1.2.2	Pictographs	7
1.2.3	Instructions/Abbreviations used	7
1.2.4	Labels/Screen prints	7
2	Safety	9
2.1	Safety precautions	9
2.2	Protective equipment	10
2.3	Proper use	11
2.4	Improper use	11
3	Transport and storage	12
3.1	Transport	12
3.2	Storage	12
4	Product description	14
4.1	Product identification	14
4.1.1	Scope of delivery	14
4.2	Product overview	14
4.2.1	Detection module	15
4.2.2	Electronic module	15
4.2.3	Industrial control panel (option/accessory)	15
4.3	Interface connection	16
4.4	Test methods	17
4.4.1	Hard vacuum test	17
4.4.2	Sniffing test mode	17
5	Installation	18
5.1	Securing the modules	18
5.1.1	Detection module	18
5.1.2	Electronic module	19
5.1.3	Industrial control panel	21
5.2	Connecting the part/installation to be tested	22
5.2.1	Detection module vacuum circuit	22
5.2.2	Prerequisites for optimising measurement	23
5.2.3	Installation instructions to be observed	23
5.2.4	Gross Leak Mode port connection	24
5.2.5	Normal mode port connection	24
5.2.6	High Sensitivity Mode port connection	25
5.2.7	Connection on the Gross Leak, Normal and High Sensitivity mode ports	26
5.2.8	Connection in Sniffer mode	26
5.3	Connection to the mains power supply	27
5.4	Connecting the exhaust	27
5.5	Gauge connection (accessory)	27
5.5.1	Installation	27
5.5.2	Setting	28
5.5.3	Atmospheric pressure/ Limit pressure adjustments	29
5.6	Operating for the first time	29
5.6.1	Familiarise yourself with the control panel	29
6	Operation	30
6.1	Control panel	30
6.1.1	Description	30
6.1.2	Contrast - Brightness - Screen Saver	31
6.1.3	Application screens	32
6.1.4	"Standard" screen	33
6.1.5	"Settings" screen	33
6.1.6	"Graph" screen	34

6.1.7	"Vacuum circuit" screen	34
6.1.8	"Measurement" window	34
6.1.9	Function keys	35
6.2	Prerequisites to use	35
6.3	Switching the detector on	35
6.3.1	Switch on	35
6.3.2	Starting a test	35
6.4	Monitoring operation	36
6.5	Shutdown the detector	36
6.6	Saving and downloading the product's configuration	36
6.6.1	Saving the configuration	36
6.6.2	Downloading the configuration	36
6.7	Calibration	37
6.7.1	Purpose	37
6.7.2	Calibrated leaks	37
6.7.3	Calibration with the internal calibrated leak	37
6.7.4	Calibration with an external calibrated leak	38
6.7.5	Machine calibration	38
6.7.6	Calibration with a pumping system in parallel	39
6.7.7	Sniffing calibration	40
6.7.8	Dynamic calibration	41
6.7.9	Calibration control	41
7	Advanced settings	42
7.1	"Graph" screen	42
7.1.1	Description	42
7.1.2	Settings	42
7.1.3	Recording	43
7.1.4	Graph clearing	44
7.1.5	Viewing a recording	44
7.1.6	Saving a recording	46
7.2	Settings	46
7.2.1	Tree diagram of the "Settings" menus	47
7.3	Set points Menu	54
7.3.1	Audio alarm and digital voice	54
7.3.2	Pollution function	55
7.3.3	Background Max	55
7.3.4	Hard Vacuum reject point	56
7.3.5	Sniffing reject set point	56
7.3.6	Probe clogged set point	56
7.3.7	Additional pressure set point	56
7.4	"Test" Menu	57
7.4.1	Test methods	57
7.4.2	Correction factor	57
7.4.3	Test mode	58
7.4.4	Automatic Cycle End	58
7.4.5	Memo function	59
7.4.6	Zero activation	59
7.5	Spectro Menu	59
7.5.1	Tracer gas	60
7.5.2	Filament parameters	60
7.5.3	Calibrated leak	60
7.6	Maintenance Menu	61
7.6.1	Detector	61
7.6.2	Timers	61
7.6.3	Detector Information	62
7.6.4	Pump Information	62
7.6.5	Event history	63
7.6.6	Calibration history	63
7.6.7	Last maintenance	64
7.7	Configuration Menu	64
7.7.1	Time - Date - Unit - Language	64
7.7.2	Function keys	64
7.7.3	Application screens	66
7.7.4	Screen Settings	67
7.7.5	Access - Password	67
7.8	Advanced Menu	70
7.8.1	Leak Detection Menu	70

7.8.2	Leak Detection: Start-up timer	70
7.8.3	Leak detection: Detector pressure gauge	70
7.8.4	Leak Detection: External gauge	71
7.8.5	Leak detection: Analyzer cell	72
7.8.6	Leak Detection: Calibration	72
7.8.7	Leak detection: Dynamic calibration	73
7.8.8	Signal processing	75
7.8.9	Input/Output menu	75
7.8.10	Input/Output: Serial Link 1 and Serial Link 2	75
7.8.11	Input/Output: I/O connector	76
7.8.12	Secondary pump speed	76
7.8.13	SD Card menu	77
7.8.14	Service	77
8	Maintenance / replacement	78
8.1	Maintenance intervals and responsibilities	78
9	Service	79
10	Accessories	80
11	Technical data and dimensions	81
11.1	General	81
11.2	Technical data	81
11.3	Dimensions	82
12	Appendix	83
12.1	ASI 20 MD / ASI 30 / ASI 35 specific features	83
	Declaration of conformity	84

1 About this manual

1.1 Validity

This operating manual is for customers of Pfeiffer Vacuum. It describes the functioning of the designated product and provides the most important information for safe use of the unit. The description follows applicable EU guidelines. All information provided in this operating manual refers to the current state of the product's development. The documentation remains valid as long as the customer does not make any changes to the product.

Up-to-date operating instructions can also be downloaded from www.pfeiffer-vacuum.com.

This manual covers products with the following part numbers:

Part number	Description
Sxxx0x0xMM9A	ASI 35 (all models)

1.1.1 Applicable documents

Documents relevant for the use of options and/or accessories, and for product maintenance are the following:

ASI 35	Operating instructions
RS-232 Operating Instructions	P/n 121777*
Operating instructions for the 15-pin I/O board	P/n 121776*
Operating instructions for the 37-pin I/O board (Ethernet + USB)	P/n 121782*
Profibus Operating instructions	P/n 127566*
Profinet Operating instructions	P/n 127567*
Internal calibration kit Operating instructions	P/n 123588*
Sniffing kit Operating instructions	P/n 123589*
Standard Sniffer Probe Operating instructions	P/n 121780*
Smart Sniffer Probe Operating instructions	P/n BG5268BE*
Spray Gun Operating instructions	P/n 121781*
ASI 20 MD type module Operating instructions	P/n 123358*
2xxx/3xxx type module Operating instructions	P/n 123359*
ASI 35 Maintenance instructions	P/n 123356M
Machine declaration of conformity	Included with this manual

*also available at www.pfeiffer-vacuum.com

1.2 Conventions

1.2.1 Safety instructions

Operating manual safety instructions Pfeiffer Vacuum are based on the UL, CSA, ANSI Z-535, SEMI S2, ISO 3864 and DIN 4844 certification standards. This document describes the following information and danger levels:

DANGER
Imminent danger Indicates an imminent hazardous situation that will result in death or serious injury.
WARNING
Possibly imminent danger Indicates an imminent hazardous situation that can result in death or serious injury.
CAUTION
Possibly imminent danger Indicates an imminent hazardous situation that can result in minor or moderate injury.
NOTICE
Command or note Command to perform an action or information about properties, the disregarding of which may result in damage to the product.

1.2.2 Pictographs



Prohibition of an action to avoid any risk of accidents, the disregarding of which may result in serious accidents



Warning of a displayed source of danger in connection with operation of the unit or equipment



Command to perform an action or task associated with a source of danger, the disregarding of which may result in serious accidents

1.2.3 Instructions/Abbreviations used



Work instruction: you must perform an operation here.

[XXXX]

You must press the **XXXX** key on the control panel.

I/O

Inputs/Outputs



Example: press the "Home" key on the control panel to return to the "Standard" screen.

⁴He

Helium 4

³He

Helium 3

H₂

Hydrogen

1.2.4 Labels/Screen prints

This chapter lists all the labels or screen prints that could appear on the product as well as their meaning.

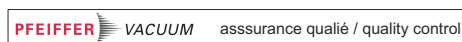

Safety label: guarantee that the packing has not been opened since leaving the factory.



Locate a grounding point on the product.

**PRODUIT PERSONNALISE
CUSTOMIZED PRODUCT**

Customization label for the product according to the customer's request.



Quality: certifies that the product has been certified compliant with quality control upon leaving the factory.



Product subject to the treatment of waste electronic and electrical equipment in accordance with directive 2002/95/EC.

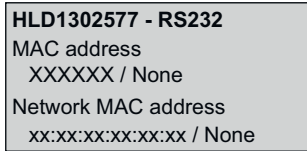

Indicates if the Ethernet option is installed on the product and its MAC address.

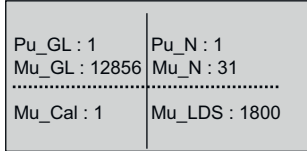

For service centers use only.

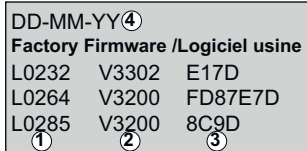

Indicates the firmware versions installed on the product.

- 1) Firmware name
- 2) Firmware version
- 3) Firmware checksum
- 4) Publication date

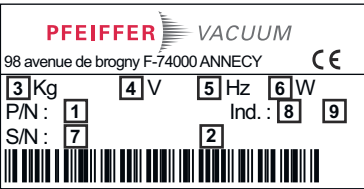

Product identification label (see 4.1).

- Each module has an identification label.
- The detector's identification label is located on the vacuum module.

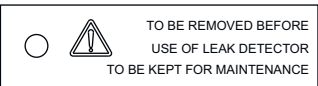

Indicates that the blanking flange fitted on the valve must be removed before using the leak detector.

Keep for maintenance or storage

DISCONNECT BEFORE MAINTENANCE

Indicates an electrical shock hazard in case of contact:

⇒ disconnect the power supply (on the product and the customer's installation) before working on the product.

⚠ DO NOT OPERATE WITH UNDERGROUNDED POWER CORD

Indicates an electrical shock hazard in case of contact:

⇒ do not use the product if the power cable is not earthed.

CONTROL PANEL

Control panel

MAIN POWER

Mains power supply

PRESSURE

Pressure

NETWORK

Network

USB

USB

SERIAL

Serial Link

INPUTS/OUTPUTS

Inputs/Outputs

VACUUM BLOCK

Vacuum block

ACCESSORIES

Accessories

HIGH SENS

High Sensitivity Mode

NORMAL

Normal mode

GROSS

Gross Leak Mode

FOREPUMP

Roughing pump

90/240V 50-60Hz Max 300W

Operating voltage - Operating frequency - Maximum power consumption

2 Safety

2.1 Safety precautions



Obligation to inform

Any person responsible for installing, using or maintaining the product must first read the security instructions in this operating manual and comply with them.

→ It is the operating customer's responsibility to protect all operators against the dangers associated with the product, with the media pumped and with the entire installation.



Obligation to keep the operating instructions available

Any person responsible for installing, using or maintaining the product must be able to consult the product operating instructions and maintenance instructions.

→ It is the operator's responsibility to make these manuals available for consultation at the place the product is used.



Installation and use of the accessories

The products can be fitted with special accessories. The installation, use and refurbishment of the connected accessories are described in detail in the respective manuals.

→ Only use original accessories.
→ Accessory part numbers: see **Accessories**.



DANGER

Hazard linked to magnetic fields

Powerful magnetic fields may disturb or interfere with the operation of electronic products, e.g. cardiac pacemakers.

→ Keep a safety distance of at least 10 cm between the pacemaker and the magnet or avoid any disturbance from powerful magnetic fields by installing suitable shielding.



WARNING

Hazard associated with non-compliant electrical installation

Safe operation after installation is the operator's responsibility.

→ Connect the product to an installation that is compliant with local safety standards.
→ Do not carry out any alterations or modifications to the product on your own initiative.
→ For specific questions, contact your service center.



WARNING

Electric shock in case of contact

When the product's circuit breaker is set at **O**, some internal components still have an electrical charge.

→ Always ensure that the mains connection is visible and accessible so that it can be disconnected at any time.
→ Disconnect the power cable at both ends from all power sources before starting any work on the product.



WARNING

Other localized hazardous energies

Electrical circuit and other pressurized circuits as nitrogen are potential hazards:

→ Always lock out these energy sources before working on the product.



WARNING

Risk associated with process gases

A leak detection operation must be carried out under environmental conditions that do not present any risks to the operator and the equipment. The user and/or integrator of the product are fully responsible for the operational safety conditions of the equipment. Therefore the user of the detector must:

- not test parts or equipment with traces of harsh, chemical, corrosive, inflammable, reactive, toxic, or explosive substances, nor condensable vapours even in small amounts. Do not use the purge system to dilute these hazardous products: that is not what it is intended for!
- apply specific safety instructions in accordance with local regulations. For more information, contact your service center.

The potential hazards concerning a leak detector involve electricity, the tracer gas and the pressurised nitrogen supply.

- Only qualified personnel trained in safety rules (EMC, electrical safety, chemical pollution) may carry out the installation and maintenance described in this manual. Our service centers can provide the necessary training.
- Do not remove the blanked-off flange from the inlet port while the product is not in use.
- Do not expose any part of the human body to the vacuum.
- Comply with all safety and risk prevention instructions in accordance with local safety standards.
- Regularly check compliance with all precautionary measures.
- Do not turn on the product if the covers are not in place.

2.2 Protective equipment

In some situations, personal protective equipment must be worn when handling the detector and its components. Customers must provide operators with the necessary equipment. This equipment must be checked regularly and used in accordance with the supplier's recommendations.



WARNING

Risk of injury due to falling objects

When transporting parts/components and during maintenance there is a danger of loads slipping and falling down.

- Carry small and medium-size parts/components with both hands.
- Carry parts/components > 20 kg with a suitable lifting device.
- Wear safety shoes with a steel toe in accordance with directive EN 347.



WARNING

Risk of injury through hot surfaces

The products are designed so as not to present a thermal risk for the operator's safety. However, specific operating conditions may exist that require extra caution from users due to the high temperatures (surfaces > 70 °C for parts inside the covers).

- Leave the part to cool before working on the product.
- If necessary wear protective gloves according to directive EN 420.

2.3 Proper use



NOTICE

EC conformity

The manufacturer's declaration of conformity becomes invalid if the operator modifies the original product or installs additional components.

→ Following installation into a plant and before commissioning, the operator must check the entire system for compliance with the valid EU directives and reassess it accordingly.

- The leak detector is designed to detect and/or quantify a possible installation or component leak by searching for the presence of a tracer gas in the pumped gases.
- Only the tracer gases identified in this manual may be used.
- The parts to be tested must be clean and dry.
- The product may be used in an industrial environment.

2.4 Improper use

Improper use will cause all claims for liability and warranties to be forfeited. Improper use is defined as usage for purposes deviating from those mentioned above, especially:

- pumping harsh, chemical, corrosive, inflammable, reactive, toxic or explosive fluids
- pumping of liquids
- pumping of condensing vapors
- pumping dust or solid particles
- operation in potentially explosive areas
- analysis of gas with a hydrogen concentration higher than 5 %
- testing parts that are soiled or that have traces of water, vapours, paint, adhesive, detergent or rinsing products
- use of accessories or spare parts, which are not named in this manual

The product is not designed to carry people or loads and is not for use as a seat, step-ladder or any other similar purpose.

3 Transport and storage

Upon delivery, check that the product has not been damaged during transport. If the product is damaged, take the necessary measures with the carrier and notify the manufacturer. In all situations we recommend:

- Keeping the product in its original packaging so it stays as clean as it was when dispatched by us. Only unpack the product once it has arrived at the location where it will be used.
- Keeping the packaging (recyclable materials) in case the product needs to be transported or stored.
- Keeping the blanking flanges on the various inlet ports when the product is not in use.

3.1 Transport



NOTICE

Work/Handling the detector

The operator must not work on the product to move it or carry out maintenance until it has come to a complete shutdown! When the circuit breaker is set at **O**, you must:

- Disconnect the mains cable at both ends.
- Wait 5 minutes starting to work on the product.

3.2 Storage



NOTICE

Obligation to inform

We took care to provide you with a clean product. So that it stays clean, we recommend storing it in its original packaging.

- Store the electronic module, the detection module and the industrial control panel in their original packaging (with the detection module's turbomolecular pump in a vertical position).
- Do not store the product with a desiccant in its packaging.

Storage valve

The detection module is delivered with a blanking flange fitted with a manual storage valve on one of the two Gross Leak inlet ports. This valve is used to place the product under vacuum, protect it from any pollution and thus ensure its performance is optimal.

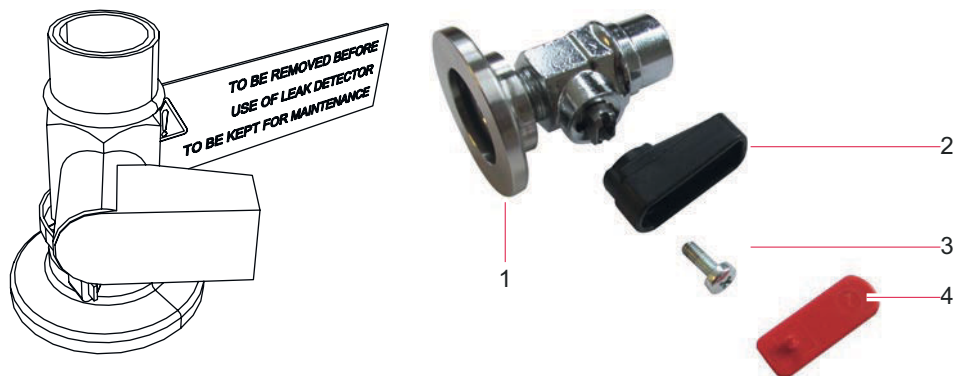

- Valve fitted with a female 1/8 connector.
- The lever on the control valve has been removed to transport the detector. The lever is delivered in the detector packaging (kit with parts 2, 3 and 4). It is not necessary to refit the lever to remove the blanking flange.

- The blanking flange/valve assembly (1) must be removed before using the detector, whatever the installation configuration of the detector in the customer's equipment may be. **Keep it in order to re-use it subsequently when transporting the detector or storing it for an extended period.**



Procedure for storing a new product

If the lever is lost, a screwdriver can be used to open and close the valve.

Procedure to be used for storage lasting more than three months:

- Leave it in its packaging.
- Leave the blanking flange in place on each inlet port.
- Store it in a clean, dry environment for a maximum of 3 months, in accordance with the temperature conditions specified in the **Technical Characteristics** (see 11.2).

Beyond 3 months, factors such as temperature, humidity, salt in the air, etc. could damage some components (elastomers, lubricants, etc.). If this happens, contact your service centre.

Procedures for extended periods of storage after use

Procedures to be used before any periods of extended shutdown and/or before dismantling the detector: the detection module thus remains under vacuum, avoiding a long degassing time the next time the equipment is started up.

Keeping the detector in the customer's installation:

- Perform a test.
- Stop the detector and wait for the turbomolecular pump to completely stop.

Dismantling the detector from the customer's installation:

- Stop the detector and wait for the turbomolecular pump to completely stop.
- Disconnect the detection module from the installation.
- Place a blanking flange on each High Sensitivity and Normal inlet port.
- Place a standard blanking flange on one of the two Gross Leak ports.
- Check that the control lever is fitted on the blanking flange/storage valve assembly (fit it if it has been removed) and that the valve is open.
- Place the blanking flange/valve assembly on the 2nd Gross Leak port.
- Connect a pumping system (or a primary pump) to the storage valve and create a vacuum inside the detection module.
- Close the storage valve and remove the control lever to prevent any air accidentally entering (keep the lever for subsequent use).
- Disconnect the pumping system from the storage valve.
- Store the detection module in its original packaging.

4 Product description

4.1 Product identification

To correctly identify the product when communicating with Pfeiffer Vacuum, always have the information from the rating plate available.

This nameplate can be consulted on the detection module (2 labels: 1 on the connection port side and 1 on the module frame).

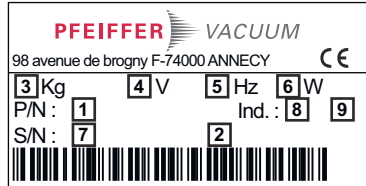

Fig. 1: Nameplate example

1	Part number
2	Description
3	Weight
4	Supply voltage
5	Supply frequency
6	Maximum power consumption
7	Serial number
8	Index
9	Date of manufacture

4.1.1 Scope of delivery

- 1 leak detector (1 detection module + 1 electronic module)
- 1 mains power cable for Europe (France/Germany) and 1 mains power cable for the US
- 1 documentation set (USB key, operating instruction, plastic coated memos for the detector and the RS-232)
- 1 maintenance kit
- 1 1/2 rack plate for electronic module
- 4 mounting lugs for electronic module
- 1 control lever for the storage valve
- 1 industrial control panel with its cable (according to the selected option)
- 1 cable to connect the electronic module and the vacuum module (15-pin D-Sub connector - length according to the selected option)
- 1 cable to connect the electronic module and the vacuum module (25-pin D-Sub connector - length according to the selected option)
- 1 connector (male 15-pin D-Sub or male 37-pin D-Sub, according to the selected option)
- 1 adaptor for use of the Smart sniffer probe (if Sniffer option selected)
- 1 screw for SplitFlow 50 pump (see the **Maintenance instructions for the detector**)

4.2 Product overview

The product comprises:

- a 1/2 rack 19" 3U-compatible electronic module (1)
- a detection module (2)
- an industrial control panel compatible 1/2 rack 19" 3U (option or accessory) (3)



- The detection module and the electronic module are connected by 2 cables, length 1.5 m/3.5 m/5 m or 10 m according to the selected option.
- The electronic module and the industrial control panel (option/accessory) are connected by one cable, length 1.8 m/5 m or 10 m according to the selected option.

4.2.1 Detection module

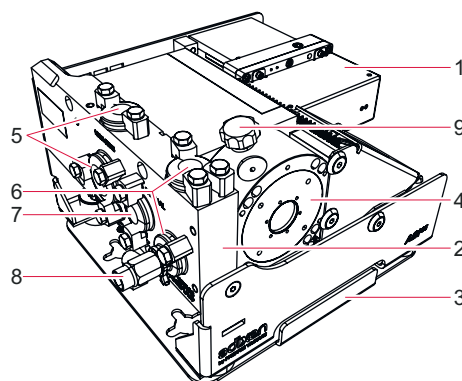

1	Analyzer cell	6	Gross Leak Mode detector inlet port: 2 x DN 16 ISO-KF
2	Vacuum block	7	Normal Mode detector inlet port: 1 x DN 16 ISO-KF
3	Fixing bracket	8	Storage valve (see 3.2)
4	SplitFlow 50 secondary detection pump	9	Turbomolecular pump decompression knob (for maintenance use only)
5	High Sensitivity Mode detector inlet port: 1 x DN 16 ISO-KF and 1 x DN 25 ISO-KF		

- The detection module does not include primary pumping (at the customer's expense).

4.2.2 Electronic module

Description: Mark **B** (see 4.3).

- Electronic module fixing lugs are provided so that the module can be secured (see 5.1.2).
- A plate is delivered with the detector so that the unit can be front mounted in a 19" ½ rack bay (see 5.1.2).

4.2.3 Industrial control panel (option/accessory)

Description: Mark **A** (see 4.3).

4.3 Interface connection

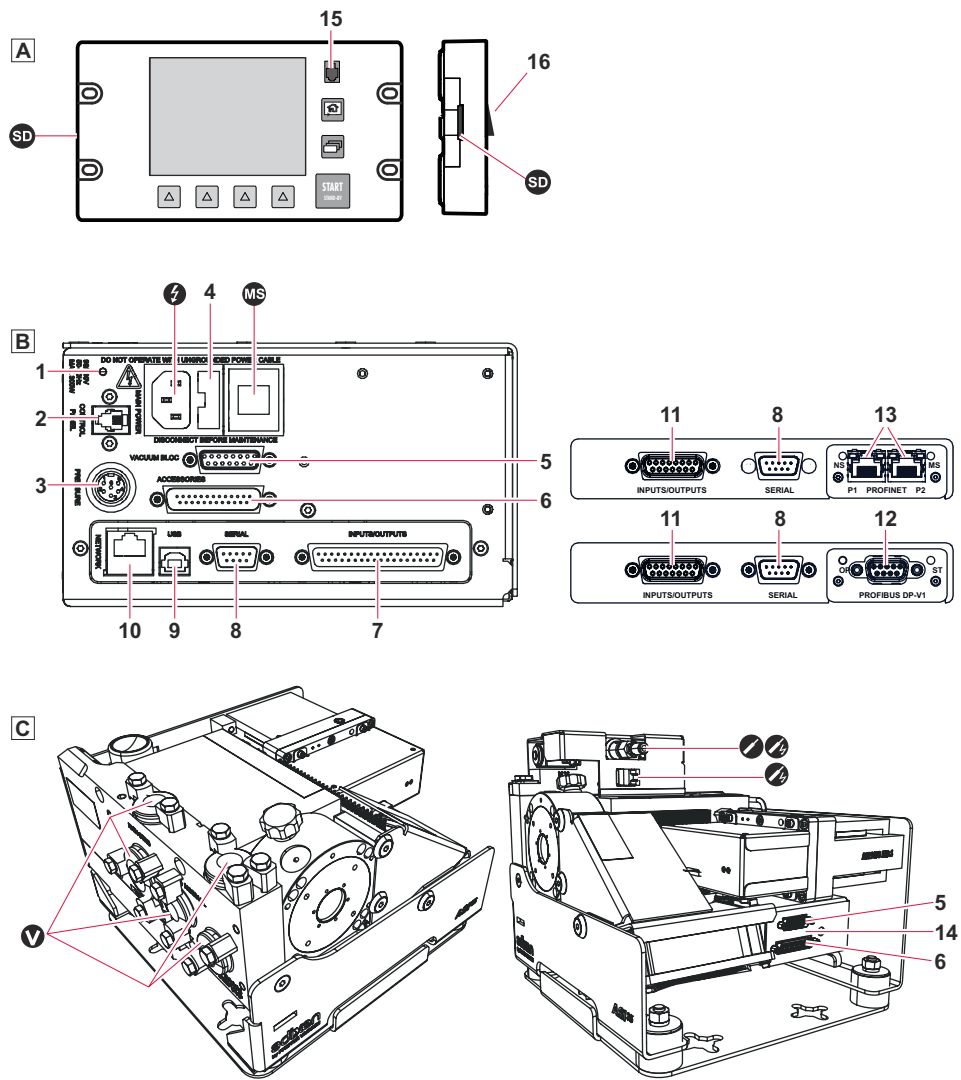

Fig. 2: Human-machine interface

A Industrial control panel ⁽¹⁾			
15	Standard remote control connector ⁽²⁾	SD	SD card
16	Buzzer connector (at the customer's expense)		
B Electronic module			
1	Detector ON indicator LED	9	USB connector (USB) ⁽³⁾
2	Industrial control panel connector (see Maintenance instructions) (CONTROL PANEL)	10	Ethernet connector (NETWORK) ⁽³⁾
3	Pressure gauge connector (PRESSURE)	11	15-pin D-Sub I/O connector (INPUTS / OUTPUTS) ⁽⁴⁾⁽⁵⁾
4	Fuses	12	9-pin D-Sub Profibus connector (PROFIBUS DP) ⁽⁵⁾
5	Electronic module/vacuum block 15-pin D-Sub connector (VACUUM BLOCK)	13	RJ45 Profinet connector (PROFINET) ⁽⁴⁾
6	Electronic module/vacuum block 25-pin D-Sub connector (ACCESSORIES)	⚡	Mains power supply (MAIN POWER)
7	37-pin D-Sub I/O connector (INPUTS / OUTPUTS) ⁽³⁾	⚡	Switch/Circuit breaker
8	RS-232 connector (SERIAL) ⁽³⁾⁽⁴⁾⁽⁵⁾		
C Detection module			
5	Electronic module/vacuum block 15-pin D-Sub connector	V	Detector inlet ports (see 4.2.1)

Fig. 2: Human-machine interface

6	Electronic module/vacuum block 25-pin D-Sub connector	●	Standard sniffer probe connection ⁽²⁾
14	24V presence indicator LED	●	Smart sniffer probe connection ⁽²⁾

- (1) Accessory or option (at the customer's expense)
 (2) Accessory (at the customer's expense)
 (3) If 37-pin I/O option (at the customer's expense)
 (4) If Profinet option (at the customer's expense)
 (5) If Profibus option (at the customer's expense)

4.4 Test methods

The test method is chosen depending on the part to be tested. For more information about leak detection test methods, see **Leak detector compendium** on the website www.pfeiffer-vacuum.com.

4.4.1 Hard vacuum test

- Part that can be connected to pipe and placed under a vacuum.
- Part that can be placed in a vacuum chamber.

Spray method This method involves removing the air from the part to be tested, connecting it to the detector's analyzer cell, then spraying tracer gas on the points of the part that are likely to leak.

The detector measures the flow of tracer gas that penetrates due to part leakage.

When spraying starts, the leak rate is not displayed instantaneously: there is a response time which depends on the volume V being tested and the tracer gas pumping speed S of the system at the opening of the part, according to the following relation:

$$T = V/S \text{ (where } T = \text{seconds, } V = \text{litres, } S = \text{l/s).}$$

T is the time required for the leak rate to reach 63 % of the final value.

Bombing method The part is placed ahead of time in a pressurised gas tracer chamber. The tracer gas penetrates the part through the potential leaks. Then the part is removed from the chamber and placed in another vacuum chamber and connected to the detector.

The detector measures the flow of tracer gas that leaks out of the part.

4.4.2 Sniffing test mode

- Part that can be connected to pipe and cannot be placed under a vacuum.

The part to be tested is pressurised with tracer gas.

The detector measures the flow of tracer gas that leaks out of the part through a sniffer probe that moves across all the points prone to leaking.

The detector measures the flow of tracer gas that leaks out of the part.

The measured leak rate is not an exact measurement of the leak. The sniffer probe only detects part of the tracer gas escaping from the part, depending on the distance separating the crack from the tip of the probe, and the direction of the leak in relation to the probe.

5 Installation

5.1 Securing the modules

Dimensions of the 3 modules (see 11.3).

The drawings for each module drawings are available on the operating instructions CD-ROM.



WARNING

Risk linked to integration in the equipment

The product is detector which can be integrated into equipment. It must be integrated into other equipment. It may not be used alone on a workbench for example. The integrator must ensure that the ingress protection rating of the equipment into which the detector is to be integrated is at least IP4x.

5.1.1 Detection module

Attachment



WARNING

Risk linked to attachment

The detection module can operate in any position. The module is attached by the bracket (4 crosses).

- Do not use the detector without first rigidly attaching the detection module.
- Ensure that the detection module attachment can absorb a braking torque of 620 m.N.

- The drawing of the module attachment bracket is available on the operating manual CD-ROM.
- To facilitate integration of the detection module, the module can be mounted in any position.
- For maintenance needs, it is sometimes necessary to swing aside the top part of the detection module in order to have access to the components (see the *Maintenance instructions for the detector*). Never leave the module in this position after any maintenance work. **The top part of the module must always be folded down when using the detector.**
- Ensure there is sufficient room around the detection module to allow the module to be dismantled for maintenance.

Effective integration volume

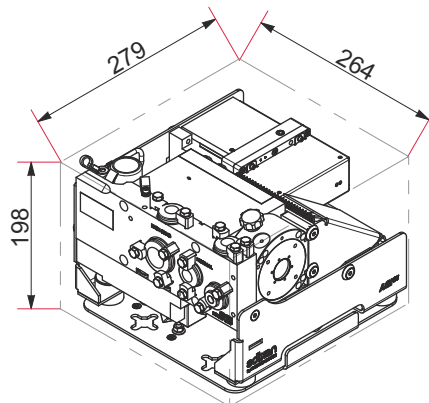

Fig. 3: Integration volume (mm)

- The effective integration volume with the Sniffer option/ accessory is larger: see the dimensions in the *Sniffer option/accessory operating instructions*.



NOTICE

Detector ventilation

If there is insufficient ventilation, overheating could cause damage to the components:

- Comply with the ambient operating temperature.
- Leave a free space of 10 cm around each side of the detection module.

Fixing bracket

- Mounting with M8 CHc screws and Ø 8 mm washers

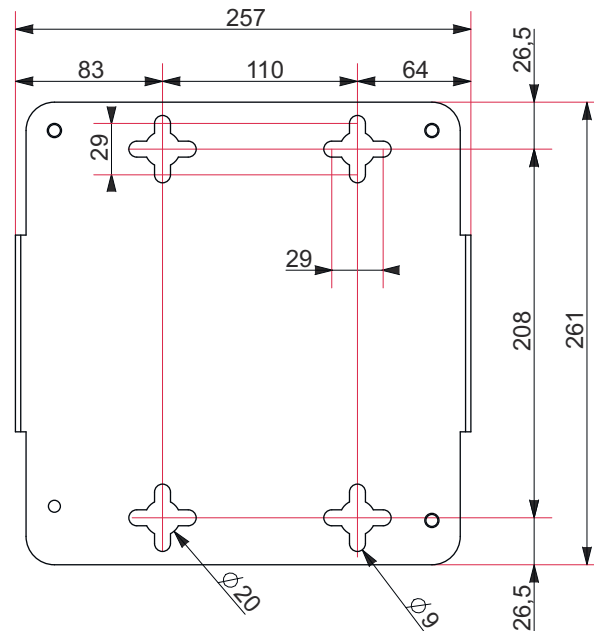

Fig. 4: Bracket viewed from above (mm)

5.1.2 Electronic module

Attachment

- The switch acts as an emergency stop: ensure access to the switch is kept free.
- To make integration easier, the electronic module can be mounted in any position.
- Leave at least 2 cm under the fan to allow the air to circulate.
- The electronic module drawings are available on the operating instructions CD-ROM.
- Ensure there is sufficient room around the electronic module to allow the module to be dismantled for maintenance.
- For maintenance needs, it is sometimes necessary to open the electronic module in order to have access to the components (*see the Maintenance instructions for the detector*). Never leave the module open after any maintenance work. **The electronic module must always be closed down when using the detector.**
- 4 mounting lugs (with mounting screws) are delivered with the leak detector: they are fixed on the different corners of the module, or instead of the feet, to attach the electronic module to a wall or other support.

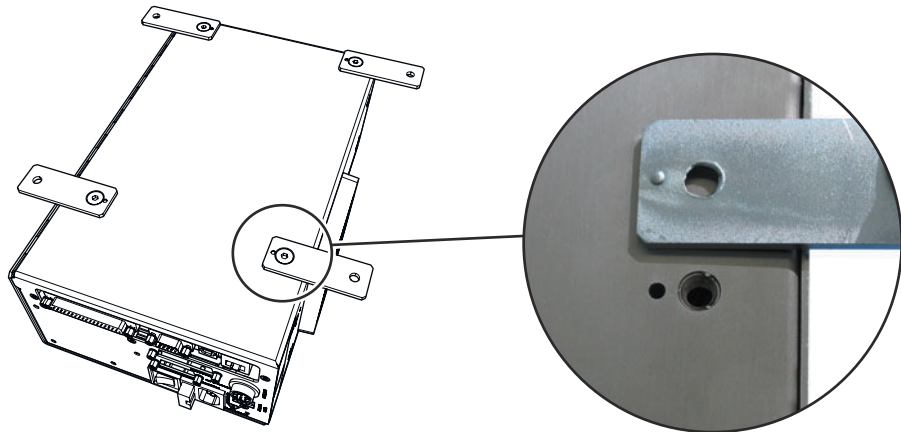

Fig. 5: Fitting of the mounting lugs

- A plate for mounting the electronic module in a 1/2 rack space is supplied with the detector (the plate drawing is available on the operating instructions CD-ROM).

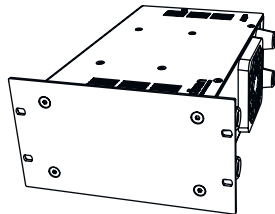
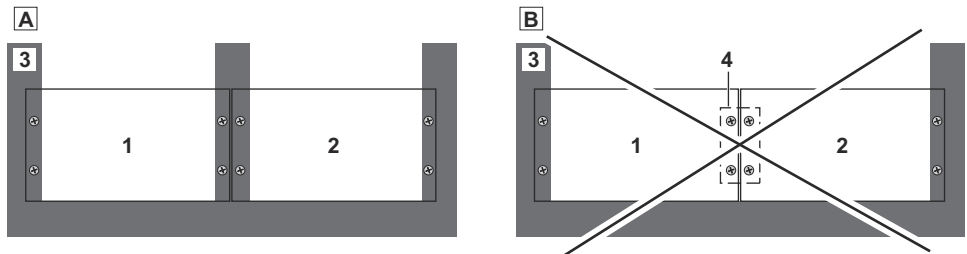

Fig. 6: Electronic module with 1/2 rack plate

Precautions to take when you fix the control panel and electronic module in a 1 rack format:



A	Correct: the electronic module and industrial control panel must be attached separately in the customer's equipment.
B	Incorrect: the electronic module and industrial control panel must never be attached together in the customer's equipment.
1	Electronic module (1/2 rack)
2	Industrial control panel (1/2 rack)
3	Customer's installation
4	Plate fixing together electronic module and industrial control panel

- The drawing of another plate, allowing the electronic module to be mounted in a 1 rack format, is available on the operating instructions CD-ROM (manufacture of this plate at the customer's expense).

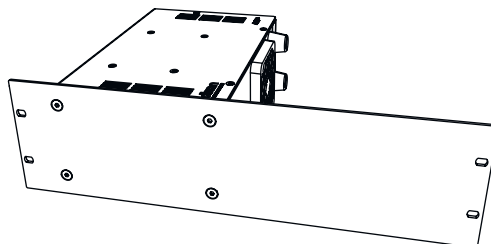

Fig. 7: Electronic module with 1 rack plate

Feet 4 rubber feet are screwed on the electronic module. They allow the module to be positioned on a table. It is possible to screw these 4 feet on the other sides of the module.

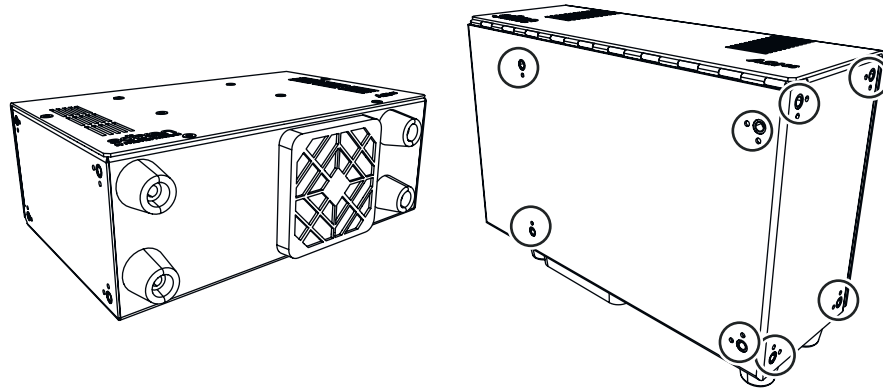
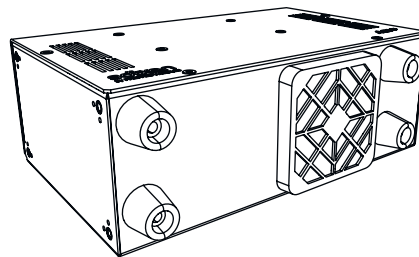
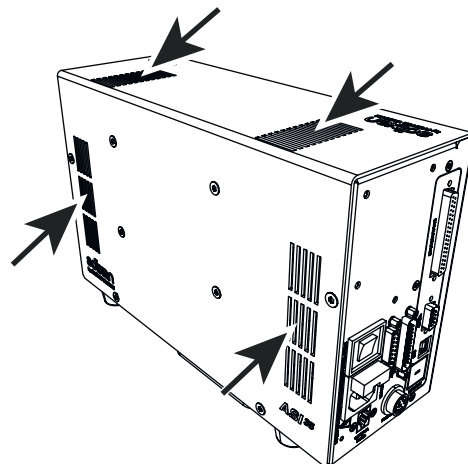

Fig. 8: Feet mounting points

Ventilation The electronic module is fitted with an internal fan associated with a protection filter on the outside.



Air vents are also provided to ventilate the electronic module.



NOTICE

Detector ventilation

If there is insufficient ventilation, overheating could cause damage to the components:

- Comply with the ambient operating temperature.
- Do not obstruct the air vents.
- Leave a gap of 10 cm around the air vents on the electronic module.

5.1.3 Industrial control panel

Industrial control panel with 1/2 rack format is available as option or accessory. The industrial control panel drawings are available on the operating instructions CD-ROM.

SD card Control panel is delivered with an SD card.

→ To remove/insert the SD card, use a thin non-metallic object.

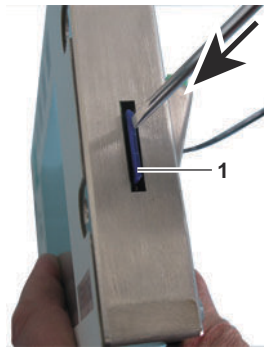

Attachment The drawing of another plate, allowing the electronic module to be mounted in a 1 rack format, is available on the operating instructions CD-ROM (manufacture of this plate at the customer's expense).

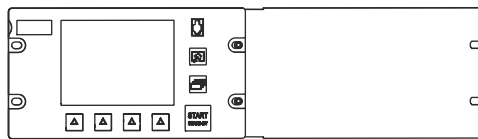

Precautions to take when attaching the control panel and electronic module in a 1 rack format (see 5.1.2).

Buzzer The leak detector is not equipped with loudspeaker. However, it is possible to connect a buzzer to the control panel:

- The wiring harness to connect the buzzer to the control panel is delivered with panel.
- Buzzer not delivered with control panel. At customer's expense.

Buzzer characteristics: 80 mA (max) / 24 V.

→ Observe +/- polarities when connecting the control panel wiring harness to the buzzer.

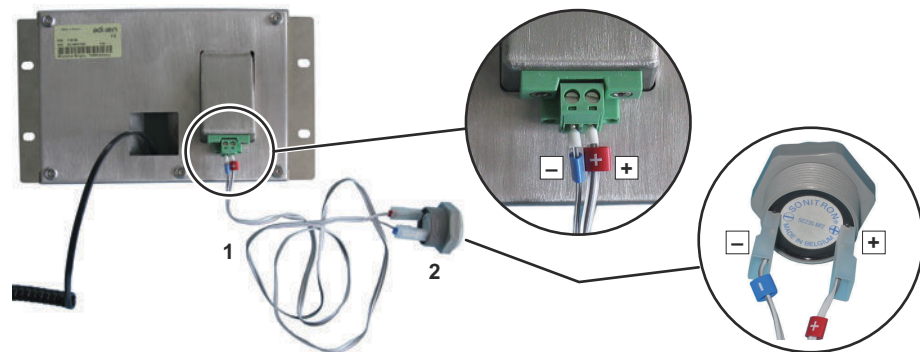

Fig. 9: Buzzer connection

1	Wiring harness (delivered with the control panel)
2	Buzzer (at the customer's expense)

→ To stop buzzer without disconnecting it, select "Mute" function through a function key (see 7.7.2).

5.2 Connecting the part/installation to be tested

5.2.1 Detection module vacuum circuit

The customer's installation will be connected to the detection module on one or more inlets: possible connections described in this chapter.

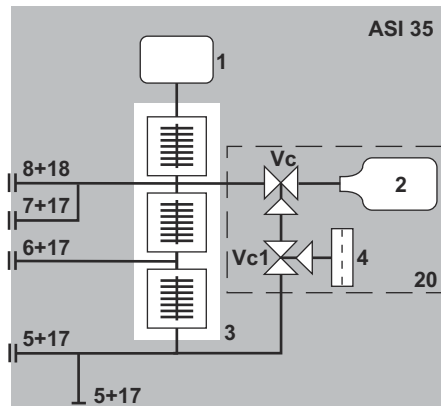

Fig. 10: ASI 35 detection module vacuum circuit

1	Analyzer cell	17	DN 16 ISO-KF blanking flange
2	Internal calibrated leak ⁽¹⁾	18	DN 25 ISO-KF blanking flange
3	Splitflow 50 turbomolecular detection pump	V _c	Calibration valve ⁽¹⁾
4	Dust filter ⁽¹⁾	V _{c1}	Leak roughing valve ⁽¹⁾
5	Gross Leak Mode inlet port: 2 x DN 16 ISO-KF	7	High Sensitivity Mode inlet port: 1 x DN 16 ISO-KF
6	Normal Mode inlet port: 1 x DN 16 ISO-KF	8	High Sensitivity Mode inlet port: 1 x DN 25 ISO-KF

⁽¹⁾ Internal Calibration option/accessory (20)

5.2.2 Prerequisites for optimising measurement

To optimise pumping and measurement speed:

- Use pipe with a diameter equal to the diameter of the detector's inlet. The pipes should be as short as possible and completely sealed.
- Do not use plastic hoses such as compressed air pipes.
- Check that the connected part/installation is impermeable to tracer gas.
- Test only clean, dry parts/installations with no trace of water, vapour, paint, detergent or rinsing products.
- Test that the entire line is completely sealed when the detector is attached to the pumping circuit, to ensure that the connections are correct (pump, pipe, valves, etc.).

5.2.3 Installation instructions to be observed



NOTICE

Limit of operation

→ Make sure that the parts or chambers connected to the inlet of our products withstand a negative pressure of $1 \cdot 10^3$ hPa in relation to atmospheric pressure.



NOTICE

Risk of pollution from solid substances

When applications generate particles, we recommend protecting the detector's inlet.

→ Install a inlet filter (see **Accessories chapter**).



DANGER

Explosion hazard.

For detecting leaks with 'hydrogen' tracer gas, the operator must use hydrogenated nitrogen (mix of 95 % N₂ and 5 % H₂).

- Comply with these recommendations (see 5.2.2) to optimise measurement.
- Comply with the environmental conditions (see 11.2).

- When assembling the vacuum circuit, use accessories to shut off the product and make maintenance easier (inlet shut off valves, purge systems, etc.).
- Connect the part or the equipment using the connection accessories available in the product catalogue.
- Remove the blanking flanges on the various inlet ports and keep them for re-use for storage or transport.
- The detector's performance depends on the type of accessories used and on the quality of the mechanical connections.
- Remove the blanking flange/storage valve assembly located on the Gross Leak inlet port whatever connection port is used for the installation (see 3.2).
- Primary pumping (at the customer's expense) shall always be connected to one of the two Gross Leak Mode inlet ports.
- Never connect the part for testing to several of the detection module's inlet ports.
- The pressure inside the product must never exceed 1 bar (absolute).
- Whatever the configuration of the customer's installation, the pressure at the detector exhaust must never exceed 18 hPa.
- Never exceed a load weight of 10 kg on an inlet port.

5.2.4 Gross Leak Mode port connection

- Installation instructions to be observed (see 5.2.3).
- Technical characteristics (see 11.2).
- Limited sensitivity.
- Very good analyser cell protection.

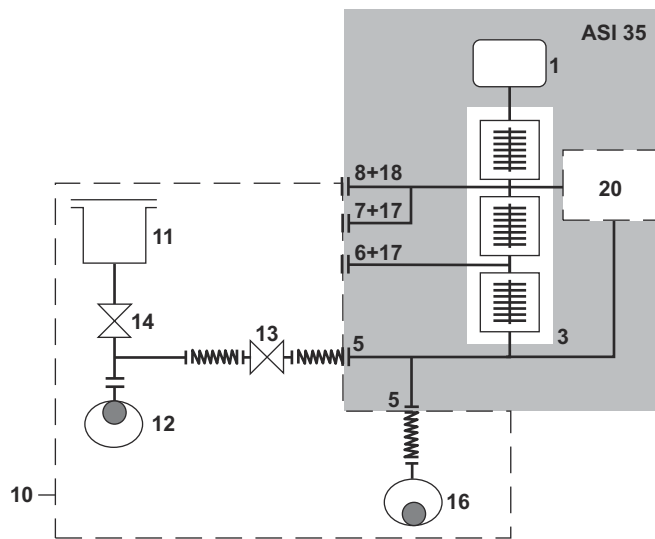

Fig. 11: Gross Leak mode connection vacuum circuit

5	DN 16 ISO-KF detector inlet port - Gross Leak Mode	13	Test valve 1 (Gross Leak mode)
10	Customer's installation	14	Roughing valve
11	Pumped chamber or part	16	Primary pump (at the customer's expense)
12	Pumping system		

- Autocalibration (if the detector is equipped with Internal Calibration): during the entire autocalibration phase, test valve 1 will be closed.

5.2.5 Normal mode port connection

- Installation instructions to be observed (see 5.2.3).
- Technical characteristics (see 11.2).
- High crossover pressure in relation to High Sensitivity mode.
- Good sensitivity.

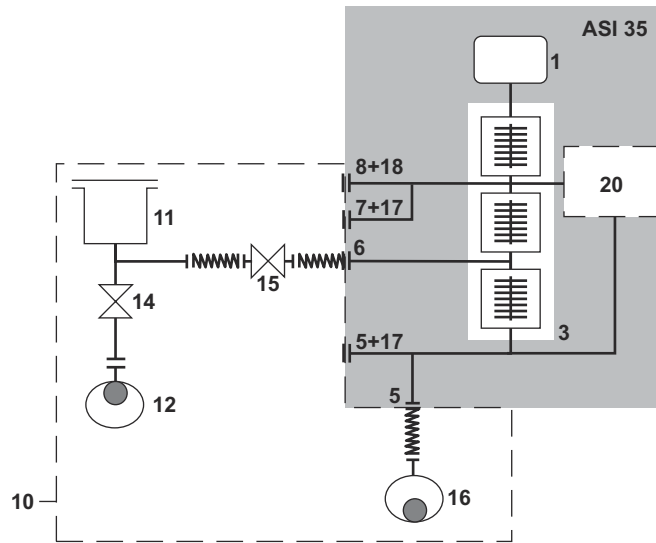

Fig. 12: Normal mode connection vacuum circuit

6	DN 16 ISO-KF detector inlet port - Normal mode	14	Roughing valve
10	Customer's installation	15	Test valve 2 (Normal mode)
11	Pumped chamber or part	16	Primary pump (at the customer's expense)
12	Pumping system		

- Autocalibration (if the detector is equipped with Internal Calibration): during the entire autocalibration phase, test valve 2 will be closed.

5.2.6 High Sensitivity Mode port connection

- Installation instructions to be observed (see 5.2.3).
- Technical characteristics (see 11.2).
- High He pumping speed.
- Very good sensitivity.

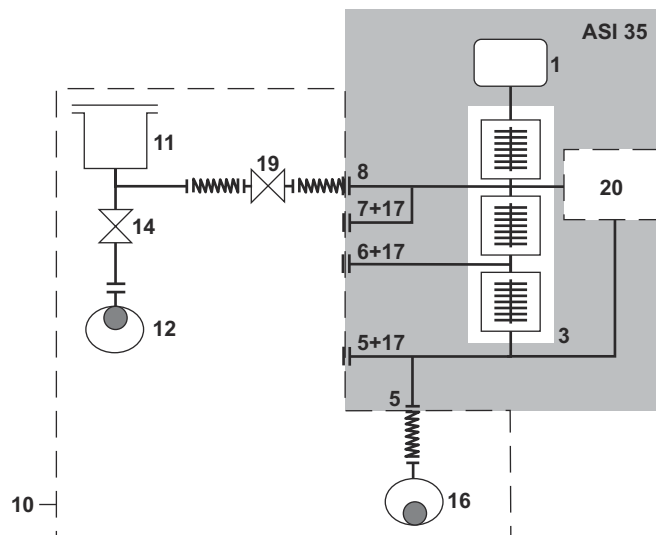

Fig. 13: High Sensitivity mode connection vacuum circuit

7	DN 16 ISO-KF detector inlet port - High Sensitivity Mode	8	DN 25 ISO-KF detector inlet port - High Sensitivity Mode
10	Customer's installation	14	Roughing valve
11	Pumped chamber or part	16	Primary pump (at the customer's expense)
12	Pumping system	19	Test valve 3 (High Sensitivity mode)

- Autocalibration (if the detector is equipped with Internal Calibration): during the entire autocalibration phase, test valve 3 will be closed.

5.2.7 Connection on the Gross Leak, Normal and High Sensitivity mode ports

- Installation instructions to be observed (see 5.2.3).
- Technical characteristics (see 11.2).
- Connecting the customer's installation simultaneously on an inlet port for each mode allows the customer to work in the 3 test modes.

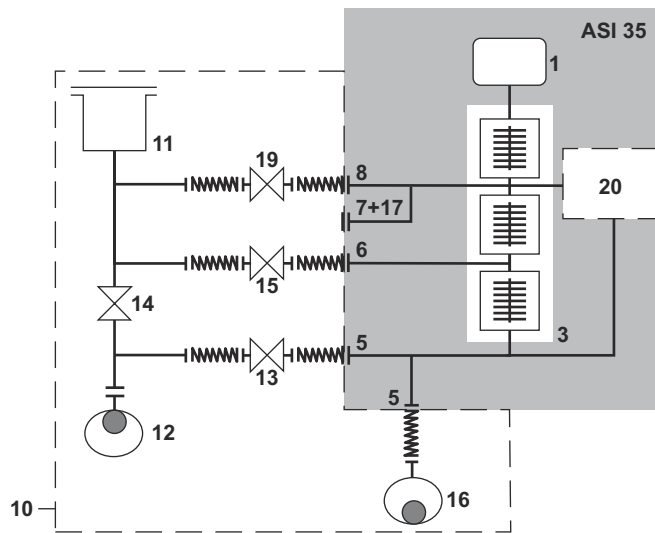

Fig. 14: Gross Leak, Normal and High Sensitivity mode connection vacuum circuit

5	DN 16 ISO-KF detector inlet port - Gross Leak Mode	7	DN 16 ISO-KF detector inlet port - High Sensitivity Mode
6	DN 16 ISO-KF detector inlet port - Normal mode	8	DN 25 ISO-KF detector inlet port - High Sensitivity Mode
10	Customer's installation	13	Test valve 1 (Gross Leak mode)
11	Pumped chamber or part	15	Test valve 2 (Normal mode)
12	Pumping system	19	Test valve 3 (High Sensitivity mode)
14	Roughing valve	16	Primary pump (at the customer's expense)

- Autocalibration (if the detector is equipped with Internal Calibration): during the entire autocalibration phase, test valves 1, 2 and 3 will be closed.

Frequency	Test valve			Cross over threshold on test
	1 (Gross Leak)	2 (Normal)	3 (High Sensitivity)	
1500 Hz	Opened	Closed	Closed	18 hPa
	Closed	Opened	Closed	1 hPa
	Closed	Closed	Opened	0.2 hPa
1000 Hz	Opened	Closed	Closed	18 hPa
	Closed	Opened	Closed	3.5 hPa
	Closed	Closed	Opened	0.1 hPa

5.2.8 Connection in Sniffer mode

Consult the Operating instructions for the Sniffer option/accessory.

5.3 Connection to the mains power supply



WARNING

Risk of electromagnetic disturbance

The product's EMC behavior is guaranteed only if the relevant EMC standards are followed during installation.

→ Use shielded cables and connections for the interfaces in interference-prone environments.



WARNING

Hazard associated with non-compliant electrical installation

Safe operation after installation is the operator's responsibility.

- Connect the product to an installation that is compliant with local safety standards.
- Do not carry out any alterations or modifications to the product on your own initiative.
- For specific questions, contact your service center.

The leak detector is Class 1 equipment and therefore must be earthed.

5.4 Connecting the exhaust



Limit of operation

→ Make sure the exhaust pressure of the installation does not exceed 200 hPa (relative). Pressure that is too high can damage the product.

The detection module does not include primary pumping. The primary pump is at the customer's expense.

5.5 Gauge connection (accessory)

Get a gauge which is compatible with the detector and its connection cable.

Models of gauge to be used: CMRxxx - APRxxx - TPRxxx - PCRxxx.

5.5.1 Installation

The pressure gauge can be installed in any part of the vacuum system for which a pressure indication is required.

E.g. installation of the gauge and control of the test valves by the electronic module equipped with the 37-pin I/O option/accessories.

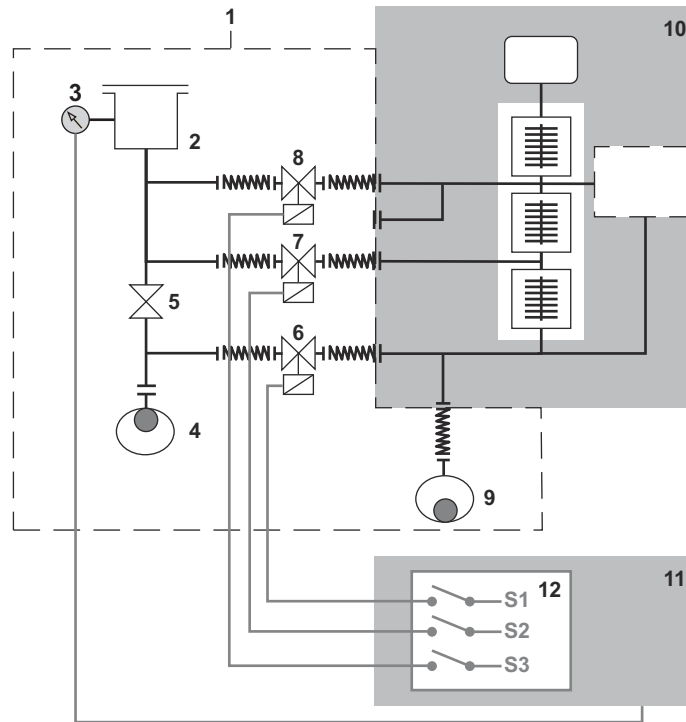

Fig. 15: Gauge connection

1	Customer installation
2	Chamber or part to be tested
3	Gauge
4	Pumping system
5	Roughing valve (V_{PREV})
6	Test valve 1 (V_{TEST1})
7	Test valve 2 (V_{TEST2})
8	Test valve 3 (V_{TEST3})
9	Primary pumping
10	Vacuum module
11	Electronic module
12	I/O 37-pin option

5.5.2 Setting

Each one of the 3 adjustable thresholds allows a relay output to be switched. These set points are defined in Set Points menu (see 7.3.7):

- set point 1: "Press s.pt #1" digital output - direct current (switch to Gross Leak mode)
- set point 2: "Press s.pt #2" digital output - direct current (switch to Normal mode)
- set point 3: "Press s.pt #3" digital output - direct current (switch to High Sensitivity mode)

Digital outputs are active only when the leak detector is in a cycle.

In order to be able to control the test valves by the detector only, the 2 set points are never enabled at the same time.

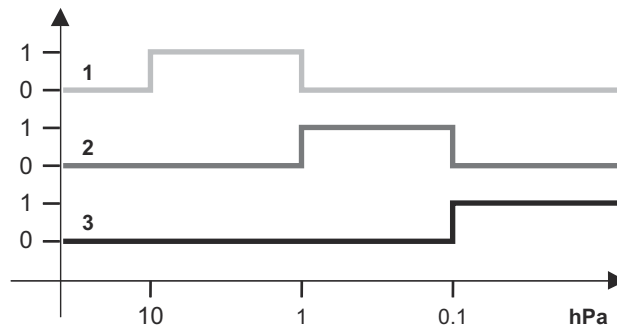



Fig. 16: Relay activation

5.5.3 Atmospheric pressure/ Limit pressure adjustments



→ Refer to instructions delivered with the gauge used.

5.6 Operating for the first time

- Make sure the customer's primary pump is connected to the detector and powered up.
- Attach the electrical network to the connector ⚡ using the power cable delivered with the detector.
- Set the circuit breaker  to I.
- Set the language, unit, time and date (the operator can modify this at a later time(see 7.7.1)).
- Wait for the detector to enter Stand-by mode.

5.6.1 Familiarise yourself with the control panel

Control panel description (see 6.1.1).

- Press  several times to familiarise yourself with the application screens.
- Press  several times to see the 2 levels of function keys available.
- For each level, press  or the control panel function key to access the function.

Note The control panel is available for this detector as an accessory or option.

6 Operation

6.1 Control panel

Industrial control panel with 1/2 rack format is available as option or accessory. It is interfaced with the detector and is used to:

- display information about the test
- access the available functions
- setting of the detector's parameters.



For a screenshot, set a function key to [Screen Copy] (see 7.7.2).



If the screen is out of order, functions remain accessible: use RS-232 to pilot/set the detector.

6.1.1 Description

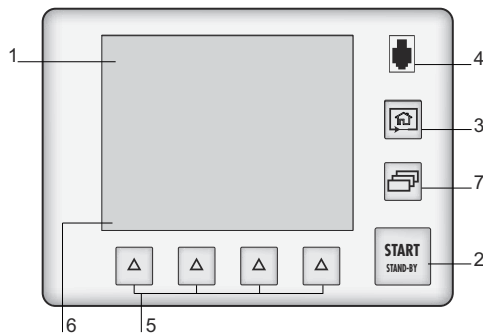











Fig. 17: Control panel

1	Application screens (touch screen): these are accessible or hidden (see 7.7.3).
2	Test Start/Stop.
3	Changing the application screens: return to the home page (standard screen) from any menu.
4	Standard remote control connection (accessory).
5	Quick access to the functions. Functions assigned to a key by the operator (provides access to the functions if there is a problem with the touch screen).
6	Displaying a function key level: starting the function or displaying a sub-menu by touching the screen.
7	Changing the level of function keys.

- ➔ Remove the film that protects the screen upon delivery.
- ➔ Use the touch screen manually without using hard objects such as pens, screwdrivers, etc.

	Function deactivated (OFF)
	Function activated (ON)
	Authorized access without password
	Access locked: access with password
	"Grey" key: access settings or function
	"White" key: key not customisable, for information
	"Measurement information" key: to display the measured leak rate

	Arrows for navigating within the menus
	Access to the error/warning window
	Value selected is customisable
	Keys for setting the values
	Moving to the next function/screen/parameter
	Return to the previous display
	Return to the previous display and confirm the changes made
	Return to the previous display without confirming the changes made
	Deleting the selected file

Set point setting



xxxxxxx 1.0 x10⁻⁰⁷ mbar.l/s

1  → 1.0 x10⁻⁰⁷

2  → 1.0 x10⁻⁰⁷

3  → 1.0 x10⁻⁰⁷

1	Exponent setting
2	Mantissa unit setting
3	Mantissa tenth setting

6.1.2 Contrast - Brightness - Screen Saver

(see 7.7.4)

6.1.3 Application screens

The content of the screens is given as an example. Depending on the leak detector and parameters, the display may be different.

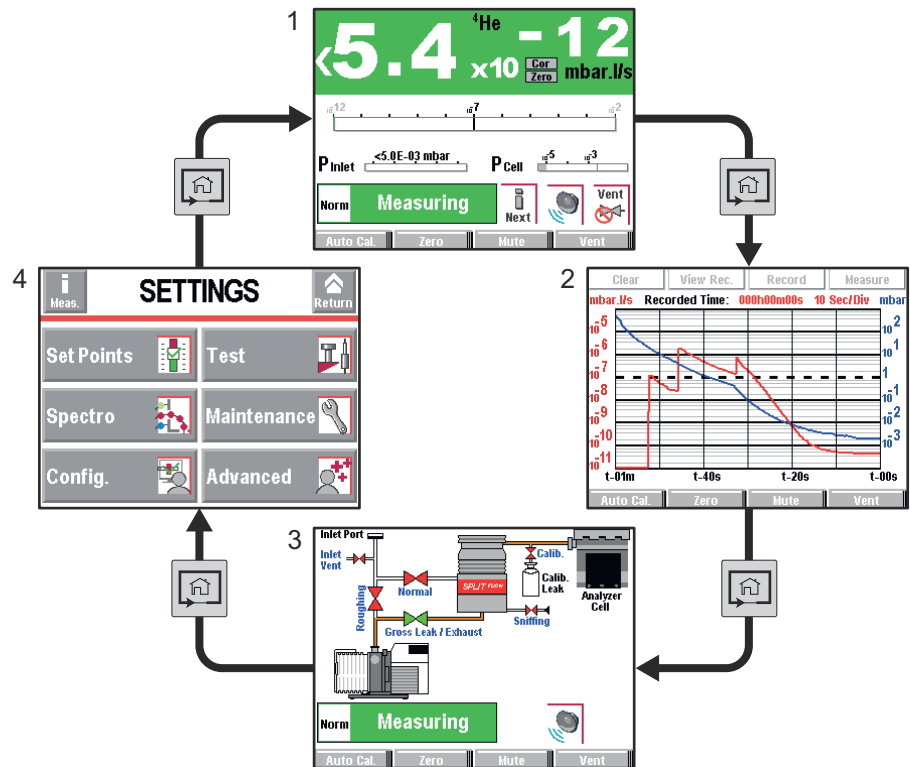

Fig. 18: Example of each screen

- | | |
|---|--|
| 1 | "Standard" screen (home) |
| | Information about the current test |
| 2 | "Graph" screen |
| | Monitoring and recording the leak rate and/or the inlet pressure |
| 3 | "Vacuum circuit" screen |
| | Vacuum circuit of the detector and the status of the valves |
| 4 | "Settings" screen |
| | Detector parameters |



The operator can hide and/or switch certain screens in the loop (see 7.7.3).

6.1.4 "Standard" screen

Information about the test: display most often shown during a test.

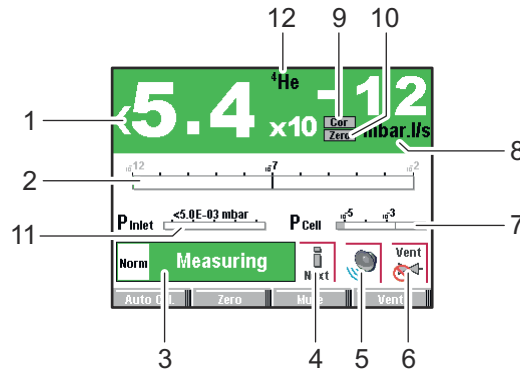

1	Digital display of the leak rate (green \leq reject set point < red)
2	Bargraph display of the leak rate (adjustable scale)
3	Detector status and Detection mode
4	Access error information
5	Mute function indicator
6	Air inlet function indicator (except ASI 30/35)
7	Cell pressure bargraph display
8	Leak detector unit
9	Leak rate correction function indicator
10	Zero function indicator
11	Detector inlet pressure display (unit consistent with the leak rate unit)
12	Tracer gas (^3He , ^4He or H_2)



A password can be used to lock access to the "Settings" menus while leaving certain functions accessible using the function keys (see 7.7.2).

ASI 30/35: Inlet pressure (11) = 10^3 on a permanent basis if no pressure gauge connected.

6.1.5 "Settings" screen

Setting the detector's parameters.

The "Settings" screen is accessible from any window, by pressing the following two keys at the same time + .

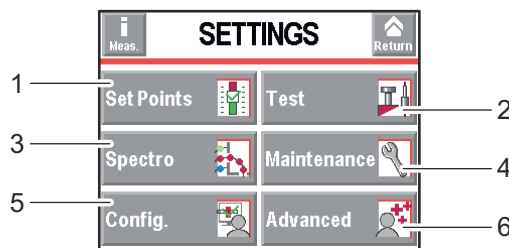

1	Set points setting: reject set point, audio level, digital voice, pollution.
2	Method and test mode selection. Inlet vent management. Correction value. Cycle end.
3	Tracer gas selection. Setting the calibrated leak.
4	Scheduling maintenance
5	Detector setting for the operator: language, unit, password, function keys, application screens.
6	Advanced functions reserved for specific detector uses.

6.1.6 "Graph" screen

Monitoring and recording the leak rate and/or the inlet pressure.

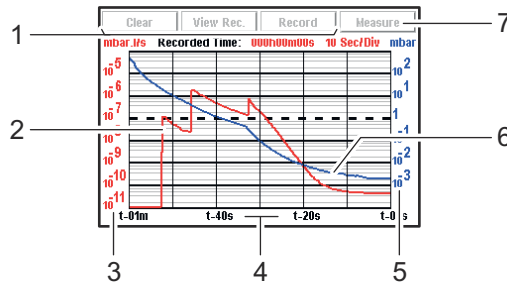

1	Deleting/Viewing/Recording a plot
2	Plot of the tracer gas leak rate (in red)
3	Scale of the tracer gas leak rate (in red)
4	Time scale
5	Inlet pressure scale (in blue)
6	Inlet pressure plot (in blue)
7	Displaying/Hiding the Measurement window (see 6.1.8)

ASI 30/35 : Inlet pressure plot (6) = 10^3 on a permanent basis if no pressure gauge connected.

6.1.7 "Vacuum circuit" screen

Vacuum circuit of the detector and the status of the valves.

Vacuum circuit is specific for each leak detector.

The vacuum circuit varies depending on the status of the valves, but does not make it possible to manage the valves.

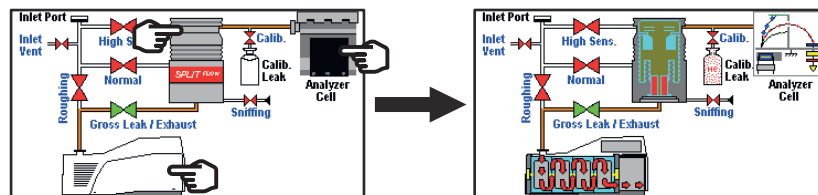

Fig. 19: Example

Red valve	Valve closed
Green valve	Valve open
Pumps, Analyzer cell	⇒ Press the component to display the operating principle.

6.1.8 "Measurement" window

→ Press the **[Measure]** key to display the window.

→ Press and drag the window to move it on the screen.



Fig. 20: [Measure] key and corresponding window

1	Digital display of the leak rate (green \leq reject set point < red)
2	Detector test mode
3	Error information indicator
4	Zero function indicator
5	Leak rate correction function indicator

6.1.9 Function keys

The function keys are used to activate/stop a function or to set set points (see 7.7.2). Thanks to the function keys, it is possible to give the operator access to a limited number of functions.

6.2 Prerequisites to use

The leak detector is set to perform a hard vacuum test in the most sensitive test mode according to the initial settings (see 7.2.1).

For use with any other parameters or other functions, see **Chapter 7**.



NOTICE	
Connecting the primary pump	
→ The external primary pump must be connected and powered up before the detector is switched on.	

Before each start-up:

- Become familiar with the safety instructions (see 2).
- Check that all the connections are correct (see 5).
- Before use, make sure that the leak detector is in an environment free of tracer gas.
- Check that the electrical network is properly attached to the connector ⚡ using the power cable.

6.3 Switching the detector on

6.3.1 Switch on

- Set the circuit breaker **MS** to **I** (see 4.3).

The various stages for switching the detector on are displayed. The detector is ready for testing when the Stand-by screen appears.

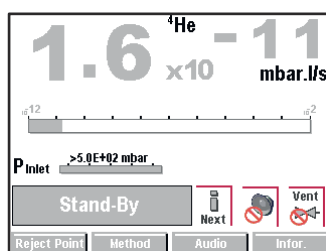

Fig. 21: Stand-by screen

Switching the detector on for the first time

(see 5.6)

Switching on after an extended shutdown

If the detector has been stored or has not been used, switching on time will be longer than if it is in regular use.

6.3.2 Starting a test

There are 2 possible test methods: hard vacuum or sniffing (see 4.4).

Hard vacuum test

- Prepare the part to be tested (see 4.4.1).
- Select the 'hard vacuum' test method (see 7.4.1).
- Set the detector to Stand-by mode.

In Stand-by mode, the leak rate displayed corresponds to the detector's background.

- Connect the part to be tested to the leak detector inlet port or put the part in the test chamber connected to the leak detector.



- Set the reject set point if necessary (see 7.3.4).
- Start a test by pressing  .

The various test stages are displayed.

- When the detector has reached the most sensitive test mode, wait for the measurement to stabilise: the measurement displayed corresponds to the measured leak rate.
- Stop the test by pressing  .

The test can also be started using a remote control (accessory): see *Remote control* Operating instructions.

Sniffing test mode

- Prepare the part to be tested (see 4.4.2).
- Select the 'sniffing' test method (see 7.4.1).
- With the leak detector in Stand-by mode, connect the sniffing probe (accessory) to the provided connector ().
- Set the reject set point if necessary (see 7.3.5).
- Start a test by pressing  : the leak rate is displayed.
- Stop the test by pressing  .

To perform the sniffing test, the "sniffing kit" option/accessory must be used (see 10).

6.4 Monitoring operation

When the detector is in use, the operator is alerted to incidents as follows:

- Pictogramme display indicating that the error message should be read.
- Error display on the screen.

Message list: see **List of warnings/faults** in *Maintenance instructions*.

6.5 Shutdown the detector

- Set the circuit breaker  to **O** (see 4.3).
- Wait for the turbomolecular pump to completely stop before working on the product.
- Wait for the control panel screen to turn off completely before working on the product and/or removing the covers.
 - It is normal for the screen to switch off approximately 3 seconds after the product power supply is switched off.

Shutdown due to a mains power failure

When there is a mains power failure, the detector shuts down: it switches on again automatically when power is restored. Its status (stand-by, test, calibration, etc.) will depend on the program currently running on the customer's PLC.

6.6 Saving and downloading the product's configuration

When a detector is installed or replaced, it is helpful to copy the configuration (all the parameters and operating set points programmed by the operator) of a detector that is the same model.

- Do this while the detector is switched on and in Stand-by mode.

6.6.1 Saving the configuration

- Follow the procedure for saving (see 7.8.13).

The detector's configuration will be saved on the SD card from control panel.

6.6.2 Downloading the configuration

- Follow the procedure for downloading (see 7.8.13).

The previous configuration is automatically updated.

All the detector's parameters are downloaded except the following, which must be set by the operator:

- language
- serial link (except ASM 310)
- time and date
- temperature unit (except ASI 35)
- pressure unit.

6.7 Calibration

6.7.1 Purpose

Calibration helps ensure that the leak detector is correctly adjusted to detect the tracer gas selected and display the correct leak rate. To calibrate the leak detector, one or more calibrated leaks are necessary, depending on the type of calibration.

Depending on the test method, different types of calibration can be performed.

Hard vacuum test

Type of calibration	Hard vacuum test	
	Customer's installation without pumping system in parallel	Customer's installation with pumping system in parallel
Calibration with an internal calibrated leak ⁽¹⁾	X	
Calibration with an external calibrated leak	X	
Machine calibration ⁽¹⁾	X	X
Calibration with a pumping system in parallel		X

⁽¹⁾ Detector with the Internal Calibration option/accessory

Sniffing test mode

Detector equipped with the Sniffer option/accessory

Type of calibration	Sniffing test mode
Calibration with an external calibrated leak	X ⁽²⁾
Calibration on concentration	X

⁽²⁾ The leak detector calibration process is independent from the sniffer probe flow.

6.7.2 Calibrated leaks

Each calibrated leak is supplied with a calibration certificate.

Gas	Internal calibrated leak	External calibrated leak	Minimum Value	Maximum Value
⁴ He	X	X	≈ 1 · 10 ⁻⁹ mbar·l/s ≈ 1 · 10 ⁻¹⁰ Pa·m ³ /s	1 · 10 ⁻⁴ mbar·l/s 1 · 10 ⁻⁵ Pa·m ³ /s
³ He		X	3 · 10 ⁻⁷ mbar·l/s 3 · 10 ⁻⁸ Pa·m ³ /s	1 · 10 ⁻⁴ mbar·l/s 1 · 10 ⁻⁵ Pa·m ³ /s
H ₂		X	5 · 10 ⁻⁶ mbar·l/s 5 · 10 ⁻⁷ Pa·m ³ /s	1 · 10 ⁻⁴ mbar·l/s 1 · 10 ⁻⁵ Pa·m ³ /s



The choice of calibrated leak depends on the needs of the application: use a calibrated leak from the same leak rate range as the leak to be measured.

The manufacturer does not provide calibrated leaks in ³He and H₂.

6.7.3 Calibration with the internal calibrated leak

The Internal calibration is an option/accessory for this detector.

Internal calibration can only be carried out with a calibrated leak in ⁴He, specially designed for the detector.

If the detector is used intensively, and to avoid immobilising the detector when the calibrated leak is returned to the manufacture for recalibration, you are advised to procure a spare internal calibrated leak. If this is not possible, the detector can still be used and calibrated using an external calibrated leak.

- Check the following parameters (correct if necessary):
 - test method = hard vacuum (see **Test Menu**)
 - type of calibrated leak = internal (see **Spectro Menu**)
 - calibration = operator (see **Advanced Menu**)
- Check the leak settings (corrected leak rate to take temperature and time into account if necessary) (see **Spectro Menu in the operating instructions**).
- Verify that the detector is on Stand-by mode.
- Press the **[Auto cal]** to start a calibration.



NOTICE
<p>Detector calibration</p> <p>For optimum use of the detector, 20 minutes after switching on, the detector must be calibrated. A calibration must also be performed:</p> <ul style="list-style-type: none"> • at least once a day • to optimise the measurement reliability for high sensitivity tests • if it is uncertain whether the detector is working properly • during intense and continuous operation: start an internal calibration at the beginning of each work session (e.g. work in shifts, every 8 hours).

6.7.4 Calibration with an external calibrated leak

External calibration can be used to calibrate the detector if it is not equipped with the Internal Calibration option/accessory.

The external calibrated leak is installed on the detection module or the customer's installation.

Calibration with an external calibrated leak in sniffing mode (see 6.7.7).

- Check the following parameters (correct if necessary):
 - mode = identical to the port used for the connection of the detector (example: connection on the Normal port -> selected 'Normal' mode) (see 5.2).
 - test method = hard vacuum (see **Test Menu**)
 - type of calibrated leak = external (see **Spectro Menu**)
 - calibration = operator (see **Advanced Menu**)
- Select the tracer gas of the external calibrated leak (see **Spectro Menu**).
- Check the settings and value of the external calibrated leak used (see **Spectro Menu**). Correct the temperature, month and year if necessary.
- Place the external calibrated leak on one of the ports on the detection module.
- Verify that the detector is on Stand-by mode.
- Press the **[Auto.Cal]** function key to start the calibration.
- Follow the instructions provided by the leak detector: press **[Next]** to move to the next stage.

At the end of the calibration, the detector returns to Stand-by mode.



<p>Recommended procedure when the measuring range differs from the value of the internal calibrated leak (if the detector is equipped with internal calibration)</p>

6.7.5 Machine calibration

Machine calibration requires:

- the detector to be equipped with Internal Calibration,
- the customer's installation to be equipped with an external calibrated leak (do not connect the external leak to the detection module).



**If the detector is equipped with internal Calibration, you are advised to perform a machine calibration (see 6.7.5).
If the detector is not equipped with internal Calibration, you are advised to perform an autocorrection (see 6.7.6).**



Machine calibration is advised if the leak detector is connected to an installation equipped with its own pumping system.

Before performing a machine calibration, the detector must be calibrated by performing a calibration using the internal or external calibrated leak.

- Isolate the leak detector by closing all the valves connecting it to the customer's installation.
- Place the external calibrated leak on the customer's installation.
- Check the following parameters (correct if necessary):
 - mode = identical to the port used for the connection of the detector (example: connection on the Normal port - > selected 'Normal' mode) (see 5.2).
 - test method = hard vacuum (see **Test Menu**)
 - calibration = operator (see **Advanced Menu**)
- Set the type of internal calibrated leak:
 - type of calibrated leak = internal (see **Spectro Menu**)
- Check the parameters and value of the internal calibrated leak used (see **Spectro Menu**). Correct the temperature, month and year if necessary.
- Check the following parameters (correct if necessary):
 - type of calibrated leak = machine (see **Spectro Menu**)
 - tracer gas = ^4He (see **Spectro Menu**)
- Select the tracer gas of the external calibrated leak (see **Spectro Menu**).
- Check the parameters and value of the external calibrated leak used (see **Spectro Menu**). Correct the temperature, month and year if necessary.
- Verify that the detector is on Stand-by mode.
- Press the **[Auto.Cal]** function key to start the calibration.
- Follow the instructions provided by the leak detector: press **[Next]** to move to the next stage.

At the end of the calibration, the detector returns to Stand-by mode.

6.7.6 Calibration with a pumping system in parallel

When the leak detector is connected to an installation equipped with its own pumping system, only part of the leak will be measured by the leak detector.

Calibration with a pumping system in parallel gives a direct reading of the leak rate by taking into account the loss of tracer gas of the leak pumped by the pumping unit.

There are 2 solutions to calibrate a detector with a pumping system in parallel:

- machine calibration: requires an internal calibrated leak. Solution to be used in preference if the detector is equipped with Internal Calibration (see 6.7.5).
- autocorrection: requires the detector to be calibrated beforehand by performing a calibration using the internal or external calibrated leak. The coefficient is calculated using the Correction function.

Autocorrection procedure

- The correction must be made using the same test method as that used by the operator. If the operator works using both test methods (hard vacuum and sniffing), he/she must make a correction for each method.
- Correction must be performed when the leak detector is already calibrated with its internal calibrated leak or an external leak.
- Allocate a **[Correction]** function key (see **Configuration Menu in the Operating instructions**).
- Select the 'hard vacuum' or 'sniffing' test mode.

- If 'Sniffing test', connect the sniffer probe to the detector: connect it to an external calibrated leak (see 6.7.4) or place it in a container with a known concentration.
- Press  to start a test.
- Press the **[Correction]** function key.
 - if the value of the correction factor to be applied is known:
 - Press **[Value]** and set the correction factor to be applied. The correction factor is the coefficient to be applied to the measured leak rate.
 - Press **[Return]** to exit the function.
 - if the target value is known (value of the external calibrated leak or concentration):
 - Press **[AutoCor] [Target]** and set the target value.
 - Press **[Start]**: to carry out the correction.
 - Press **[Return]** to exit the function.

The 'COR' indicator light (see *Standard screen in the Operating instructions, mark 9*) is illuminated on the control panel as soon as the value of the correction factor is not 1. The digital display takes into account the correction factor applied. The bar graph display does not take into account the correction factor applied.

6.7.7 Sniffing calibration

Sniffing is an option/accessory for this detector.

In sniffing mode, calibration is performed with an external calibrated leak or on the concentration.

Calibration with an external calibrated leak

A DN 16 ISO-KF or DN 25 ISO-KF adaptor is used to connect the external calibrated leak with the sniffer probe (Standard sniffer probe only) in order to calibrate the detector.

Adaptor part numbers (see 10).

- Check the following parameters (correct if necessary):
 - test method = sniffing (see *Test Menu*)
 - type of calibrated leak = Ext. sniffing (see *Spectro Menu*)
 - calibration = operator (see *Advanced Menu*)
- Select the tracer gas of the external calibrated leak (see *Spectro Menu*).
- Check the settings and value of the external calibrated leak used (see *Spectro Menu*). Correct the temperature, month and year if necessary.
- Attach the adaptor (1) to the external calibrated leak (2) used for the calibration with centring ring and a clamp.
- Attach the adaptor (1) to the external calibrated leak (2) used for the calibration with centring ring and a clamp.
- Connect the sniffer probe (3) to the detector (5).
- Fit the sniffer probe (3) in the calibration opening.
- Tighten the fixing screw (4). Follow the calibration process indicated on the control panel.
- Loosen the fixing screw (4).
- Remove the sniffer probe from the calibration opening.
- Follow the instructions provided by the leak detector: press **[Next]** to move to the next stage.
- Wait 10 s (at least) before reading the leak rate.

At the end of the calibration, the detector returns to its initial state (Stand-by or test mode).

At the end of the calibration, the detector returns to its initial state (Stand-by or test mode).

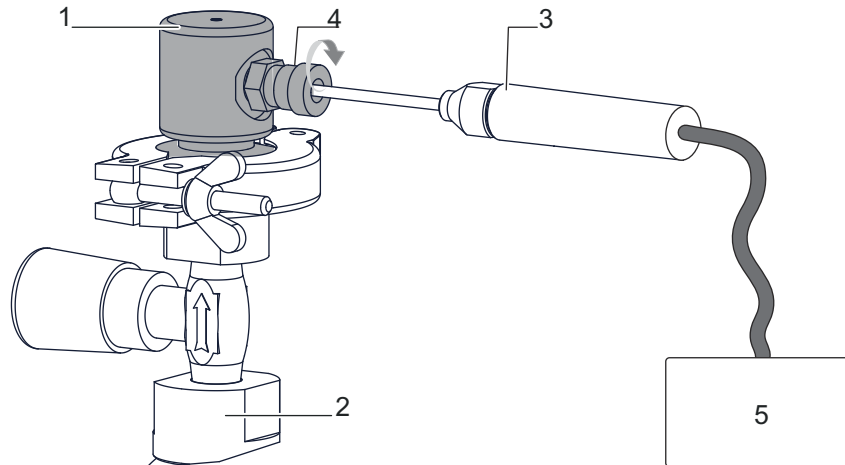

Fig. 22: Adaptor installation

Calibration on concentration

Calibration on concentration can only be carried out in sniffing test mode, with the detector in Stand-by or test mode.

Concentration = container at atmospheric pressure filled with a gas mixture for which the tracer gas content is known.



NOTICE

Before launching this function, make sure that the leak detector is in an environment free of tracer gas pollution.

- Check the following parameters (correct if necessary):
 - test method = sniffing (see **Test Menu**)
 - type of calibrated leak = concentration (see **Spectro Menu**)
 - calibration = operator (see **Advanced Menu**)
- Select the tracer gas of the concentration (see **Spectro Menu**).
- Connect the sniffer probe to the detector (see 6.7.4).
- Place the sniffer probe in the concentration.

The detector can be in Stand-by mode or in sniffing test mode.

- Press the **[Auto.Cal]** function key to start the calibration.
- Follow the instructions provided by the leak detector: press **[Next]** to move to the next stage.

At the end of the calibration, the detector returns to its initial state (Stand-by or test mode).

6.7.8 Dynamic calibration

This function allows predictive adjustment of the leak rate for repetitive tests where the test time has to be optimised (see 7.8.7)

6.7.9 Calibration control

Calibration control saves the operator time because the calibration control is quicker than the full calibration (see 7.8.6).

7 Advanced settings

7.1 "Graph" screen

→ Access the "Graph" screen by pressing .

7.1.1 Description

Monitoring and recording the leak rate and/or the inlet pressure.

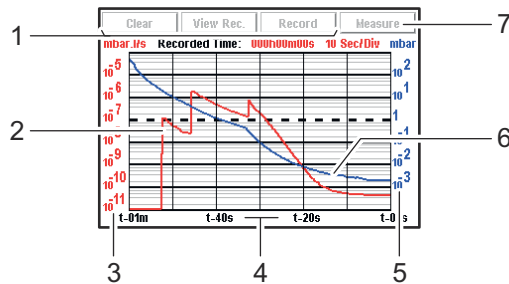

Fig. 23: "Graph" screen

1	Deleting/Viewing/Recording a plot
2	Plot of the tracer gas leak rate (in red)
3	Scale of the tracer gas leak rate (in red)
4	Time scale
5	Inlet pressure scale (in blue)
6	Inlet pressure plot (in blue)
7	Displaying/Hiding the measurement (see 6.1.8)

Scales (3), (4), (5) are adjustable by pressing the graph.

ASI 30/35 : Inlet pressure plot (6) = 10^3 on permanent basis if no external gauge connected.

7.1.2 Settings

→ Access the graph settings menu by pressing the graph.

Display

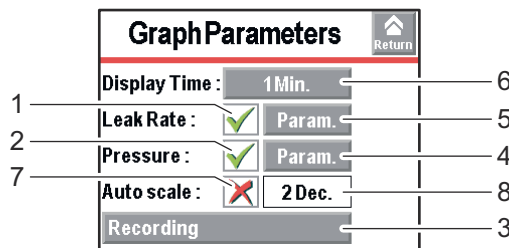

1	Displaying/Hiding the measured leak rate
2	Displaying/Hiding the inlet pressure
3	Setting the recording time
4	Setting the inlet pressure scale
5	Setting the leak rate scale (If 'automatic' scale is deactivated)
6	Screen scroll speed
7	Activating/Deactivating the automatic scale
8	Setting the automatic scale

Automatic scale

The automatic scale is used to display the measured leak rate centred on 2 or 4 decades. The scale varies according to the leak rate measured. When the automatic scale is activated, the scales set for the leak rate and pressure are no longer taken into account.

Example: leak rate = $5 \cdot 10^{-8}$ Pa·m³/s ($5 \cdot 10^{-7}$ mbar·l/s)

- automatic scale 2 decades: scale from $1 \cdot 10^{-7}$ to $1 \cdot 10^{-9}$ Pa·m³/s
($1 \cdot 10^{-6}$ to $1 \cdot 10^{-8}$ mbar·l/s)
- automatic scale 4 decades: scale from $1 \cdot 10^{-6}$ to $1 \cdot 10^{-10}$ Pa·m³/s
($1 \cdot 10^{-5}$ to $1 \cdot 10^{-9}$ mbar·l/s)

Recording → Press **[Recording]**.

Duration	Recording duration	
Capacity	Total recording time according to recording duration	
Duration	Maximum capacity	File size
0.2 s (min.)	6 hours 33 minutes	≈ 7 Mo
30 s (max.)	983 hours	

7.1.3 Recording

Recording makes it possible to store the measurements taken during the test in the control panel memory: **it will not save these measurements** (see 7.1.6).

During a recording, all the detector functions are available.

After the detector is switched off (cut off at the mains or by the operator), the recordings already made are stored in the memory. For the next recording, the operator will have to specify:

- if the new recording is to be added to the recordings in the memory **[OK]**
- if the new recording is to delete or replace the recordings in the memory **[Cancel]**.

- Change the recording parameters if necessary.
- Press **[Record]** (1) (see 7.1.1) to start recording

None of the measurements displayed on the plot before the recording starts will be recorded.

- Press **[Stop]** (1) to stop recording.
- Press **[View Rec.]** (1) to see the recording.

If the memory is not cleared between two recordings (**[Clear]** (1)), all subsequent recordings will appear consecutively on the same memorised plot. A ▲ cursor indicates the end of each recording.

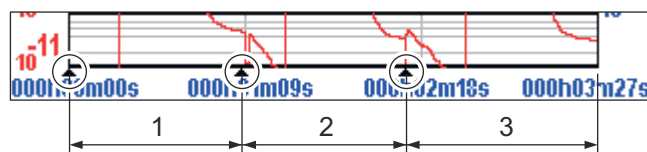
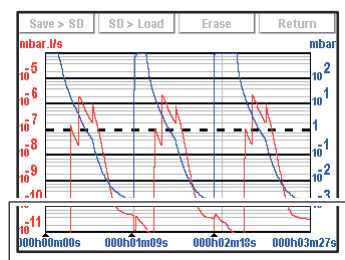

Fig. 24: Recording example

1	1 st recording
2	2 nd recording
3	3 rd recording

When the memory is full and if a recording is in progress, recording is automatically stopped.

The **[Record]** key is replaced by the **[Mem full]**.

7.1.4 Graph clearing

Current window

- Display the "Graph" screen (see 7.1.1).
- Press **[Clear]** (1) and validate the message.

Clearing the current window does not delete the current recording or recordings already made.

Recording

- Display the "Graph" screen (see 7.1.1).
- Press **[View Rec.]** (1).
- Press **[Clear]** (1) and validate the message.

If the detector is carrying out a test while the previous recording is being deleted, the test is stopped.

7.1.5 Viewing a recording



At any time, the operator can view the recording already made or zoom in on a recording, without stopping the current recording.

- Press **[View Rec.]** to view the recording made since the last recording was deleted (1) (see 7.1.1).

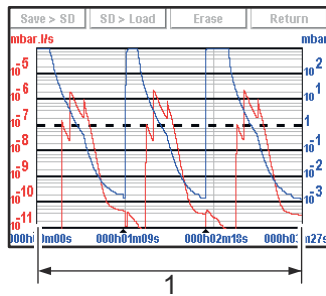

Fig. 25: Viewing a recording

1	Total recording time
---	----------------------

If no plots have been made, the message "Memory empty" is displayed.

Zoom in

- Zoom in available only for a recording.
- Press **[View Rec.]** (1) (see 7.1.1).
 - Set the area to be enlarged ((1) then (2)).

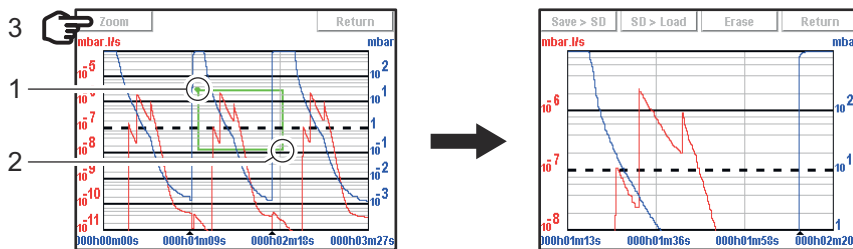

Fig. 26: Selection and viewing the area to be enlarged

- Press **[Zoom]** (3): the enlarged area is displayed.

Several successive zooms are possible (except in the same decade).



If necessary, adjust the area to be enlarged by dragging the corners or sides with your finger.

Zoom out

- Zoom out available only for a recording.
- Set the area to be reduced ((1) then (2)): return to the original graph.

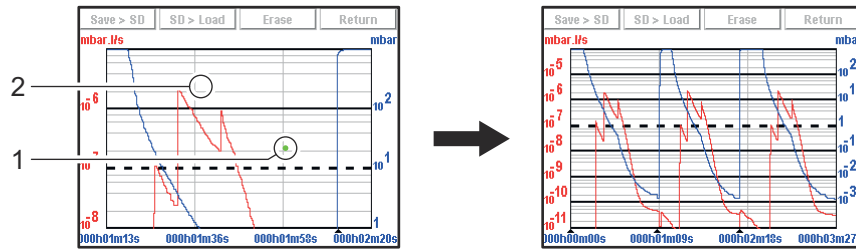

Fig. 27: Return to the original graph

Measurement

Exact measurement of a point only available on a recording.

➔ Select the point to measure (2).

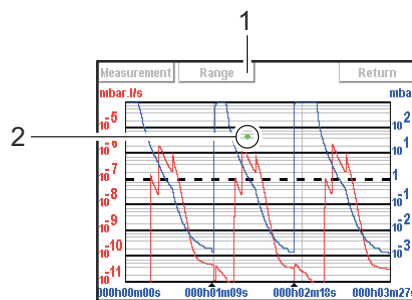

Fig. 28: Example of the recording of a point

- | | |
|---|---|
| 1 | Modifying the leak rate and inlet pressure scales |
| 2 | Point selected |

➔ Press **[Measure]**: the exact measurement of the selected point is displayed.

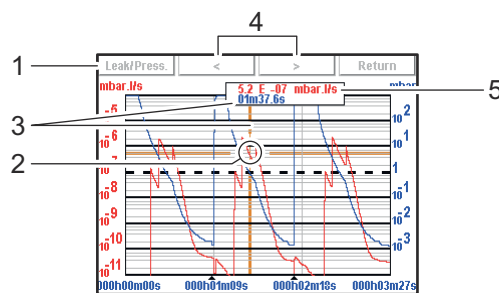

Fig. 29: Exact measurement of the selected point

- | | |
|---|--|
| 1 | Selecting the display of the leak rate or the inlet pressure |
| 2 | Marker indicating the selected point |
| 3 | Moment the measurement took place in relation to the start of the recording |
| 4 | Navigation between next/previous recorded points |
| 5 | Displaying the tracer gas leak rate (in red) or the inlet pressure (in blue) |



To make the exact values of all measurements available on any type of spreadsheet, save the recording to a .txt file.

7.1.6 Saving a recording

This function is used to save the most recent recording on a SD card to be played back/ analysed later on a PC. Saving is not automatic.

It is possible to save a screenshot of the recording (.bmp) or to generate a file (.txt) with all the measurements taken. The .txt file can be used with any spreadsheet (e.g. Excel Microsoft® Office): the default separator is "tab".

→ Press **[Save > SD]** (see 7.1.1).

→ Name the file and save it

The saved .bmp and .txt files include only the measurement points displayed on the screen:

- to include all points, you must be positioned on the relevant plot (without zooming).
- if a zoom was carried out before saving, the zoom will apply only to the points of the selected zone.

If the saved recording is made up of several consecutive recordings:



- the ▲ cursor will indicate each new recording on the .bmp files.
- "B.P. # xx" will be noted at the end of the last line of each recording in the .txt files.

.bmp files can be displayed on the control panel screen.

.txt files can be opened only from a PC.

7.2 Settings

Screen for accessing the detector's settings menus to set the detector according the application. After this, for daily operation the functions keys will be used.

The "Settings" menu is accessible from any screen by pressing 2 keys  +  on the control panel simultaneously.

Access to the various menus can be locked (see 7.7.5).

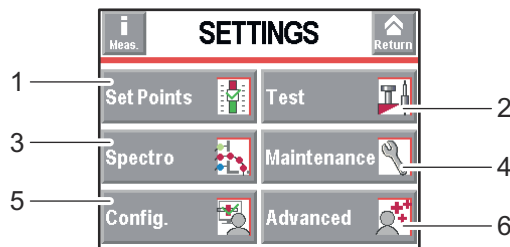

1	Setting the set points: reject set point, audio level, digital voice, pollution.
2	Method and test mode selection. Inlet vent management. Correction value. Cycle end.
3	Tracer gas selection. Setting the calibrated leak.
4	Scheduling maintenance. Detector information
5	Detector setting for the operator: language, unit, password, function keys, application screens.
6	Advanced functions* reserved for specific detector uses.

Table 1: * advanced settings requiring substantial knowledge about leak detection: pressure gauge, etc.

7.2.1 Tree diagram of the "Settings" menus

The following table shows the detector's initial settings. When the detector is off, values and parameters are saved for the next use.

The operator can save and download different leak detector configurations (see 7.8.13).

SET POINTS					
Selection			Choice - Setting limit	Initial settings	
Audio	Status		Invalid / Valid	Valid	
	Setting (If valid)		1 - 9	3	
Digital voice	Status		Invalid / Valid	Valid	
	Setting (If valid)		1 - 9	4	
Pollution	Status		Invalid / Valid	Invalid	
	Setting (If valid)		$1 \cdot 10^{+19}$ - $1 \cdot 10^{-19}$	$1 \cdot 10^{-5}$	
Background Max	Status		Invalid / Valid	Invalid	
	Setting (If valid)		$1 \cdot 10^{+19}$ - $1 \cdot 10^{-19}$	$1 \cdot 10^{-8}$	
Hard Vacuum Set Points	Reject point		$1 \cdot 10^{+06}$ - $1 \cdot 10^{-13}$	$1 \cdot 10^{-7}$	
	Set Point 2 (If I/O 37 pins)		$1 \cdot 10^{+19}$ - $1 \cdot 10^{-19}$	$1 \cdot 10^{-7}$	
	Set Point 3 (If I/O 37 pins)		$1 \cdot 10^{+19}$ - $1 \cdot 10^{-19}$	$1 \cdot 10^{-7}$	
	Set Point 4 (If I/O 37 pins)		$1 \cdot 10^{+19}$ - $1 \cdot 10^{-19}$	$1 \cdot 10^{-7}$	
	Set Point 5 (If I/O 37 pins)		$1 \cdot 10^{+19}$ - $1 \cdot 10^{-19}$	$1 \cdot 10^{-7}$	
Sniffer set Points	Reject point		$1 \cdot 10^{+06}$ - $1 \cdot 10^{-12}$	$1 \cdot 10^{-4}$	
	Probe clogged		$1 \cdot 10^{+19}$ - $1 \cdot 10^{-19}$	$1 \cdot 10^{-6}$	
Additional pressure set point	Pressure set point 1		$5 \cdot 10^{-3}$ - $3 \cdot 10^{+2}$	$1 \cdot 10^{+1}$	
	Pressure set point 2		$5 \cdot 10^{-3}$ - $3 \cdot 10^{+2}$	$1 \cdot 10^0$	
	Pressure set point 3		$5 \cdot 10^{-3}$ - $3 \cdot 10^{+2}$	$1 \cdot 10^{-1}$	
TEST					
Selection			Choice - Setting limit	Initial settings	
Method			Hard Vacuum / Sniffer	Hard Vacuum	
HV or sniffing correction	Status		Invalid / Valid	Invalid	
	Setting (If valid)		$1 \cdot 10^{+20}$ - $1 \cdot 10^{-20}$	$1 \cdot 10^{+0}$	
Mode	(If hard vacuum test method)		Gross Leak / Normal / High Sensitivity	Normal	
Automatic cycle end	Automatic cycle end		Operator / Automatic	Operator	
	Setting (If automatic) (If hard vacuum test)	Evacuation delay	Status	Invalid / Valid	Valid
			Setting (if valid)	0 - 1 h	10 s
		Test Timer		0 - 1 h	10 s
	Setting (If automatic) (If sniffing test)	Threshold Report	Status	Invalid / Valid	Invalid
		Setting (if valid)	0 - 1 h	10 s	
	Test Timer		0 - 1 h	10 s	
Memo function	Active		No / Yes	No	
	Display Time	Status	Invalid / Valid	Invalid	
		Setting (If automatic)	0 - 1 h	10 s	
Zero activation	Activation		Operator / Automatic	Operator	
	Setting (If automatic)	Trigger	Timer / Set point	Timer	
		Setting	If Timer	0 - 1 h	10 s
		If Set Point	$1 \cdot 10^{+19}$ - $1 \cdot 10^{-19}$	$5 \cdot 10^{-7}$	

Advanced settings

SPECTRO					
Selection			Choice - Setting limit	Initial settings	
Tracer Gas			Helium 4 / Helium 3 / Hydrogen	Helium 4	
Filament Selected			1 / 2	1	
Filament			Off / On	On	
Filament Status			0 - 100 %	100 %	
Calibrated leak	Tracer Gas			Helium 4 / Helium 3 / Hydrogen	Helium 4
	Type	If hard vacuum test	Without calibration	External	External
			With calibration	Internal / External / Machine	Internal
		If sniffing test		Ext. sniffing / Con- centration	Ext. sniffing
	Unit			mbar·l/s / Pa·m ³ /s / Torr·l/s / atm.cc/s / ppm	mbar·l/s
	Leak Value			-	Refer to certificate delivered with the de- tector
	Calibration valve (if 'internal' type)			Closed / open	Closed
	Loss per Year (%)			0 - 99	6
	Reference Temperature (°C)			0 - 99	23
	Temperature Coefficient (%/°C)			0.0 - 9.9	3.0
	Year			-	Refer to certificate delivered with the de- tector
Temperature	Internal Temperature (if 'internal' type)		-	-	
	External (except if 'internal' type)			To set	

MAINTENANCE					
Selection			Choice - Setting limit	Initial settings	
Detector			-	20	
Timers	Detector			-	20
	Filament 1	Counter		-	20
		Reset counter	Function launching	-	-
	Filament 2	Counter		-	0
		Reset counter	Function launching	-	-
	Calibrated leak			-	To set
	Cycles	Counter		-	0
		Interval		1·10 ⁺¹⁹ - 1	5·10 ⁵
		Reset counter	Function launching	-	-
	Secondary Pump 1	Timer (h)			20
		Time interval (h)		1 - 99999	17200
Reset counter		Function launching	-	-	
Speed (min ⁻¹)		-	-		
Detector Information	Access to general information			-	
Pump Information	Secondary Pump 1	Status		-	On
		Rotation		-	Synchro
		Speed (min ⁻¹)		-	-
		TMP information	Access to general in- formation	-	-

MAINTENANCE					
Selection			Choice - Setting limit	Initial settings	
Events History			-	Empty	
Calibration History			-	Empty	
Last maintenance	Maintenance work 1	Date	-	-	
		Nbr hours	-	-	
		Inspected by	-	-	
	Maintenance work 2	Date	-	-	
		Nbr hours	-	-	
		Inspected by	-	-	
	Maintenance work 3	Date	-	-	
		Nbr hours	-	-	
		Inspected by	-	-	
CONFIGURATION					
Selection			Choice - Setting limit	Initial settings	
Unit/Date/Time/Language	Unit		mbar·l/s / Pa·m ³ /s / Torr·l/s / mTorr·l/s atm·cc/s / ppm / sccs / sccm	To set	
	Date		mm/dd/yyyy	To set	
	Time		hh:mm:ss	To set	
	Language		English / French / German / Italian / Chinese / Japanese / Korean / Spanish / Russian	To set	
Function keys	Configuration		-	-	
Application Windows	"Standard" Window Parameters	Bargraph display of the leak rate	Zoom on Set Point	No / Yes	
			Low Decade	1·10 ⁺⁵ - 1·10 ⁻¹³	1·10 ⁻¹²
			High Decade	1·10 ⁺⁶ - 1·10 ⁻¹²	1·10 ⁻²
		Stand-By value	Hide / Show	Show	
	Inlet Pressure	Hide / Show	Show		
	Cell pressure	Hide / Show	Hide		
	Standard	Access	-	Show	
		Order	-	1 st	
	Graph	Access	Hide / Show	Show	
		Order (If Show)	2 nd - 4 th	2 th	
	Vacuum Circuit	Access	Hide / Show	Hide	
		Order (If Show)	2 nd - 4 th	-	
Settings	Access	Hide / Show	Show		
	Order (If Show)	2 nd - 4 th	3 th		

CONFIGURATION				
Selection		Choice - Setting limit	Initial settings	
Screen Settings	Brightness	High / Low	High	
	Contrast	0 - 100	50	
	Panel off	None / 15 min / 30 min / 1 h / 2 h / 4 hours	None	
	Paging Function	Without RC 500 WL remote control detected	-	None
		With RC 500 WL remote control detected	Off / On	Off
	Reset panel parameters	Function launching	-	-
Access / Password	Password	0000 - 9999	5555	
	Set Points Menu Access	Lock / Unlock	Unlock	
	Test Menu Access	Lock / Unlock	Unlock	
	Spectro Menu Access	Lock / Unlock	Unlock	
	Maintenance Menu Access	Lock / Unlock	Unlock	
	Configuration Menu Access	Lock / Unlock	Unlock	
	Advanced Menu Access	Lock / Unlock	Unlock	
	User Level	Restricted Access / Medium Access / Full Access	Full Access	
	Change Password	0000 - 9999		

ADVANCED					
Selection			Choice - Setting limit	Initial settings	
Leak Detection	Start-up timer		0 - 1 h	1 mn 30 s	
	Detector pressure gauge	Gauge	TPR / PCR / LINEAR	TPR / PCR	
		Position	Standard	Standard	
		Full scale (mbar) (if Linear)	0.1 - 50000	1000	
	External gauge	Gauge	None / TPR / PCR / Linear	None	
		External Pressure (mbar)	-	-	
		Inlet Pressure Source	Internal / External	Internal	
		Full scale (mbar) (if Linear)	0.1 - 50000	To set	
	Calibration	Calibration		Operator / Manual	Operator
		Calibration checking	Checking	Operator / Automatic	Operator
			Frequency (if automatic)	Cycles Hours	0 - 9999 0 - 9999
	Analyzer Cell	Filament Selected		1 / 2	1
		Filament		Off / On	On
		Triode pressure		-	-
		Electric Zero		-	-
		Calibration valve		-	Closed
		Target value		-	-
		Acceleration Voltage (V)		-	-
		Emission (mA)		-	-
		Sensitivity Coefficient		-	-
		Internal Temperature (°C)		-	-
	Dynamic calibration	Active		No / Yes	No
		Value (if active)		10^{+19} - 10^{-19}	$1 \cdot 10^{-7}$
Coefficient (if active)		-	1		
Signal processing	Level		Fast - Stable	Stable	

ADVANCED							
Selection				Choice - Setting limit	Initial settings		
Input/Output (I/O 15 pins if Profibus / Profinet)	Serial Link 1	Type			Serial	Serial	
		Parameters	Mode			Basic / Spreadsheet / Advanced / Data export / RC 500 WL / RC 500 / External module / HLT 5XX / HLT 2XX	Advanced
			Handshake			None / XON / XOFF	
		Power Pin 9			-	5 V	
	Serial Link 2	Type			Not used / Anybus	Anybus	
		Parameters	Mode	If Profibus	Profibus / Profinet / Ethernet/IP	Profibus	
				If Profinet		Profinet	
		Status			Sepup / New Init / Wait Process / Proc. Active / IDLE / Error	-	
		Address	If Profibus			2 - 126	To set
	If Profinet					Leak detector IP address	
I/O connector	Analog Output	9-gnd	Allocation	See Manual I/O 15 pins		Mantissa	
			Value	According to allocation		-	
		10-gnd	Allocation	See Manual I/O 15 pins		Logarithmic	
			Value	According to allocation		10 ⁻¹²	
		12-gnd	Allocation	-		Exponent	
			Value	10 ⁺² - 10 ⁻¹³		10 ⁻¹²	
ProfiBus/ProfiNet	Type			Adixen / Typ B	Adixen		
	Connected			Yes / No	Yes		
	Address	If Profibus			-	Profibus address (@xx)	
		If Profinet			-	Leak detector IP address	
	Dx/Det			No/Yes / No/Yes	Yes / Yes		
Input/Output (I/O 37 pins if option)	Serial Link 1	Type			Serial / USB	Serial	
		Parameters	Mode			Basic / Spreadsheet / Advanced / Data export / RC 500 WL / HLT 5XX / HLT 2XX	Advanced
			Handshake			None / XON / XOFF	
			Power Pin 9			-	5 V

ADVANCED Selection					Choice - Setting limit	Initial settings
Input/Output (I/O 37 pins if option)	Serial Link 2	Type			Not used / USB / Network	USB
		Parameters	Mode		Basic / Spreadsheet / Advanced / Data export	Advanced
			Handshake		None / XON / XOFF	None
I/O connector	Quick View	I/O set in the 37-pin connector				
		Analog output	37-gnd	Allocation	See Manual I/O 37 pins	Mantissa
	Value			According to allocation	-	
	36-gnd		Allocation	See Manual I/O 37 pins	Logarithmic	
			Value	According to allocation	10 ⁻¹²	
	19-gnd		Allocation	-	Exponent	
			Value	10 ⁺² , 10 ⁻¹³	10 ⁻¹²	
	Digital input	11-gnd	Allocation	See Manual I/O 37 pins	Memo	
			Activation	Rising edge / Falling edge / Impulsion	Rising edge	
		30-gnd	Allocation	See Manual I/O 37 pins	Calibration	
			Activation	Rising edge / Falling edge / Impulsion	Impulsion	
		12-gnd	Allocation	See Manual I/O 37 pins	Dynamic Cal.	
			Activation	Rising edge / Falling edge / Impulsion	Rising edge	
		31-gnd	Allocation	See Manual I/O 37 pins	Sniffer test	
			Activation	Rising edge / Falling edge / Impulsion	Rising edge	
		13-gnd	Allocation	See Manual I/O 37 pins	Zero	
			Activation	Rising edge / Falling edge / Impulsion	Rising edge	
		32-gnd	Allocation	See Manual I/O 37 pins	HV test	
			Activation	Rising edge / Falling edge / Impulsion	Rising edge	

ADVANCED Selection							
				Choice - Setting limit	Initial settings		
Input/Output (I/O 37 pins if option)	I/O connector	Digital Transistor Output	9 - 28	Allocation	See Manual I/O 37 pins	Detector Ready	
				Activation	NO / NC	NO	
			8 - 27	Allocation	See Manual I/O 37 pins	Reject point	
				Activation	NO / NC	NC	
			7 - 26	Allocation	See Manual I/O 37 pins	Calibration fail	
				Activation	NO / NC	NO	
			6 - 25	Allocation	See Manual I/O 37 pins	Detector busy	
				Activation	NO / NC	NO	
			Digital Relay Output	5 - 24	Allocation	See Manual I/O 37 pins	Press spt # 1
					Activation	NO / NC	NO
				4 - 23	Allocation	See Manual I/O 37 pins	Set point # 4
					Activation	NO / NC	NC
		3 - 22		Allocation	See Manual I/O 37 pins	Set point # 3	
				Activation	NO / NC	NO	
		2 - 21		Allocation	See Manual I/O 37 pins	Set point # 5	
				Activation	NO / NC	NC	
		1 - 20	Allocation	See Manual I/O 37 pins	General failure		
			Activation	NO / NC	NC		
		Select Default Configuration	Function launching		-	-	
		Others Configurations				Config ASI20MD / Config 2xxx / Config 3xxx	-
Load Config. from SD Card	Function launching		-	-			
SD card	Load LD Parameter	Function launching		-	-		
	Save LD Parameter	Function launching		-	-		
	Visualize *.BMP	Function launching		-	-		
Secondary Pump Speed	Actual (min ⁻¹ /Hz)			-			
	Target (min ⁻¹ /Hz)		90000/1500 / 60000/1000	90000			
Service	Access to the Service menu is password protected. Reserved for the Service Centres.						

7.3 Set points Menu

→ From the "Settings" screen, press **[Set points]** to access the menu.

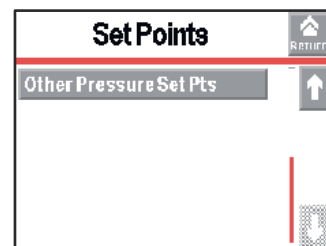
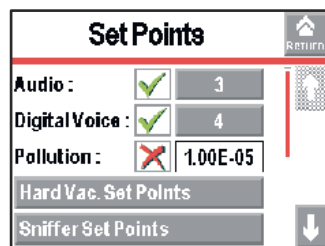

7.3.1 Audio alarm and digital voice

The audio alarm and the digital voice are not available directly on the detector. Either:

- an audio headphone or loudspeaker must be connected (maximum power: 0.5 W) to the 15/37-pin connector outputs (see **15- or 37-pin I/O board operating instructions**).
- or a buzzer must be connected to the control panel (see 5.1.3).

Audio headphone, loudspeaker or buzzer at the customer's expense.

Audio alarm The audio alarm informs the operator that the reject set point has been crossed. The level varies from 0 to 8 (0 to 90 dB (A)).

From the "Settings" screen, press [Set points].

Audio	⇒ Activate the audio level.
	⇒ Set the audio level.



For quick access from the control panel, set a function key to [Audio] (see 7.7.2).



Fig. 30: "Audio" screen using a function key

Digital voice Digital voice informs the operator about the status of the detector or actions to be carried out.

From the "Settings" screen, press [Set points].

Digital voice	⇒ Activate digital voice.
	⇒ Set the digital voice level.



For quick access from the control panel, set a function key for [Voice] (see 7.7.2).



Fig. 31: "Voice" screen using a function key

"Mute" function → Cut the audio alarm with the [Mute] key.



To launch the function from the control panel, set a function key to [Mute] (see 7.7.2).

7.3.2 Pollution function

This is a safety device for the detector. It prevents too much leaked tracer gas from penetrating the detector. We recommend setting the pollution set point to a maximum of 4 decades above the reject set point. If the leak rate rapidly increases above the pollution set point, the cycle stops automatically and the leak detector returns to Stand-by mode.

From the "Settings" screen, press [Set points].

Pollution	⇒ Activate the function.
	⇒ Set the application set point.



Useful function if the part or installation to be tested is likely to have gross leaks.

7.3.3 Background Max

This function allows to protect the detector and the installation tested by any pollution in tracer gas by forbidding any test if the detector background is upper to a predefined set point.

From the "Settings" screen, press [Set points].

Background Max	⇒ Activate the function.
	⇒ Set the application set point.

7.3.4 Hard Vacuum reject point

The hard vacuum reject point defines the acceptance set point for parts that are "accepted/rejected" in a hard vacuum test:

- Measured leak rate \leq reject set point: part accepted
- Measured leak rate $>$ reject set point: part rejected

From the "Settings" screen, press [Set points] [Hard Vacuum set points].	
Reject point	⇒ Set the reject point value.
Reject point #	4 additional reject points available with the 37 pin I/O board. ⇒ Set the set point value.

The reject set point is memorized for each configurable tracer gas.



For quick access from the control panel, set a function key for [Reject Point] (see 7.7.2).



Fig. 32: "Reject point" screen using a function key.

7.3.5 Sniffing reject set point

The sniffing reject set point defines the acceptance set point for parts that are "accepted/rejected" in a sniffing test:

- Measured leak rate \leq reject set point: part accepted
- Measured leak rate $>$ reject set point: part rejected.

From the "Settings" screen, press [Set Points] [Sniffing Set Points].	
Reject point	⇒ Set the set point value.



For quick access from the control panel, set a function key for [Reject Set Point] (see 7.7.2) and (see 7.3.4).

7.3.6 Probe clogged set point

The purpose of this set point is to check that the sniffer probe (accessory) is operational. When the measured leak rate is lower than the set 'Probe clogged' set point, the operator receives a message to check the probe. (see **Sniffing probe operating instructions**).

From the "Settings" screen, press [Set Points] [Sniffing Set Points].	
Probe clogged	⇒ Set the set point value.

- With the Standard sniffer probe, the set point unit is the unit set for the detector.
- ➔ Block the end of the sniffer probe from time to time with your finger to check that the leak rate is going down. If not, the probe may be clogged. Do not block the end for too long: if the measured leak rate decreases too much, there is risk of exiting the sniffing test.

7.3.7 Additional pressure set point

If the installation is equipped with an external gauge (at the customer's expense), 3 pressure set points can be set and controlled by the I/O (see **I/O 37-pin operating instructions**)(see 5.5) :

- pressure set point 1: threshold for switching to Gross Leak mode
- pressure set point 2: threshold for switching to Normal mode
- pressure set point 3: threshold for switching to High Sensitivity mode

From the "Settings" screen, press [Set Points] [Additional Pressure Set Point].

Pressure Set Point #	⇒ Adjust the set point value.
----------------------	-------------------------------

7.4 "Test" Menu

→ From the "Settings" screen, press [Test].

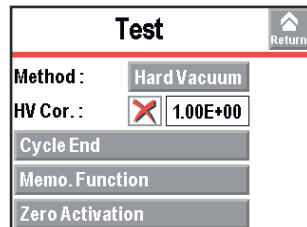

7.4.1 Test methods

There are 2 possible test methods (see 4.4):

- hard vacuum test,
- sniffing test.

To perform the sniffing test, the sniffing kit available as an option or an accessory must be used (see 10).

From the "Settings" screen, press [Test].

Method	⇒ Select the test method.
--------	---------------------------



NOTICE

Limit of operation

→ Make sure that the parts or chambers connected to the inlet of our products withstand a negative pressure of $1 \cdot 10^3$ hPa in relation to atmospheric pressure.



For quick access from the control panel, set a function key for [Method] (see 7.7.2).

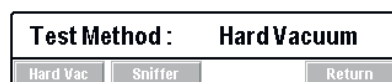

Fig. 33: "Method" screen using a function key

7.4.2 Correction factor

The correction factor allows correction of the measured leak rate by the detector:

- when it is combined with parallel pumping
- when the concentration of the used tracer gas is lower 100%.

From the "Settings" screen, press [Test].

HV Correction/Sniff. Correction	⇒ Activate the correction factor application. ⇒ Set the correction factor to be applied, if known. ⇒ If it is not known, using the [Correction] function keyclick on [Auto Cor]: calculation of the correction factor to be applied and automatic application.
---------------------------------	--



For quick access from the control panel, set a function key for [Correction] (see 7.7.2).



Fig. 34: "Correction" screen using a function key



Depending on the concentration of tracer gas used for detecting leaks, the leak rate displayed changes.

E.g. the leak rate displayed with a calibrated leak of $1 \cdot 10^{-7}$ mbar·l/s ($1 \cdot 10^{-8}$ Pa·m³/s) (with 100 % ⁴He) connected to the detector's inlet.

% He in the gas used	100 %	50 %	5 %	1%
Leak rate displayed on the leak detector without correction	$1 \cdot 10^{-8}$ Pa·m ³ /s $1 \cdot 10^{-7}$ mbar·l/s	$5 \cdot 10^{-9}$ Pa·m ³ /s $5 \cdot 10^{-8}$ mbar·l/s	$5 \cdot 10^{-10}$ Pa·m ³ /s $5 \cdot 10^{-9}$ mbar·l/s	$1 \cdot 10^{-10}$ Pa·m ³ /s $1 \cdot 10^{-9}$ mbar·l/s
Correction value	1	2	20	100
Leak rate displayed on the leak detector with correction	$1 \cdot 10^{-8}$ Pa·m ³ /s $1 \cdot 10^{-7}$ mbar·l/s			

The detector's primary pump (at the customer's expense) does not constitute parallel pumping. It does not require a correction factor implementation.

The correction factor is automatically updated during a machine calibration (see 6.7.5).

7.4.3 Test mode

A hard vacuum test can be performed as soon as one of the test modes is reached.

The leak detector will automatically switch to the test mode selected when the internal pressure reaches the crossover threshold (see 7.8.4).



For quick access from the control panel, set a function key for [Mode] (see 7.7.2).



Fig. 35: "Mode" screen using a function key



By default, the leak detector is set to work in a hard vacuum test, in the most sensitive test mode: this setting meets the majority of the operators' needs.

From the "Settings" screen, press [Test].

Mode	⇒ Set the test mode.
------	----------------------

mode = identical to the port used for the connection of the detector (example: connection on the Normal port - > selected 'Normal' mode) (see 5.2).

7.4.4 Automatic Cycle End

This function allows automatic control of the roughing time and measurement time in a hard vacuum test.

From the "Settings" screen, press [Test] [Cycle End].

Automatic cycle end	⇒ Activate the function. Function activated if 'automatic' is set.
Roughing timer (if hard vacuum test)	Setting optional if 'automatic' is set. ⇒ Activate the control for the roughing duration. ⇒ Set the maximum roughing duration allowed. If the test is still in the roughing phase when the maximum authorised time is reached, the test is stopped and the part is rejected.
Threshold Report (if sniffing test)	Setting optional if 'automatic' is set. ⇒ Activate the timer before the measured leak control. ⇒ Set the timer. If the measured leak is greater than the set reject set point when the timer runs out, the test is stopped and the part is rejected (protection of the detector in case of gross leak).

From the "Settings" screen, press [Test] [Cycle End].

Measurement time	Setting required if 'automatic' is set. ⇒ Set the measurement duration. When the duration expires, test mode is exited and the measured leak rate is displayed.
------------------	---



Function to be used to automate a small production.

7.4.5 Memo function

At the test stop, this function freezes the "Standard" screen with the leak rate measured during this test: the latest leak rate measured during the test displays and flashes.

From the "Settings" screen, press [Test] [Memo Function].

Active	⇒ Activate the function.
Display time	Setting required if the function is active. ⇒ Activate the display time delay. <ul style="list-style-type: none"> • On = the value of the measured leak rate flashes for the set duration. • Off = the value of the measured leak rate will flash until a new test begins. ⇒ Set the display duration.



For quick access from the control panel, set a function key for [Memo] (see 7.7.2).



Fig. 36: "Memo function" screen using a function key

7.4.6 Zero activation

This function is used to help the operator identify very small leak rate variations in the surrounding background or to dilate small measured leak rate fluctuations on the analogical display.

From the "Settings" screen, press [Test] [Zero Activation].

Activation	⇒ Activate the function (activated if 'automatic' is set).
Trigger	Setting required if 'automatic' is set. ⇒ Set the function trigger factor.
Value	Setting required if 'automatic' is set. ⇒ Set the function trigger value.



To launch the function manually from the control panel, set a function key to [Zero] (see 7.7.2).

→ To activate the function manually, press the [Zero] function key.



Using this function is recommended when the background of the tracer gas is stable and significant. This function is used to measure a leak rate that is lower:

- than 2 decades in hard vacuum test mode: $5 \cdot 10^{-13}$ Pa·m³/s ($5 \cdot 10^{-12}$ mbar·l/s) maximum
- than 3 decades in sniffing mode: $5 \cdot 10^{-10}$ Pa·m³/s ($5 \cdot 10^{-9}$ mbar·l/s) maximum

than the detector's background, when the detector is no longer in roughing.

7.5 Spectro Menu

→ From the "Settings" screen, press [Spectro].

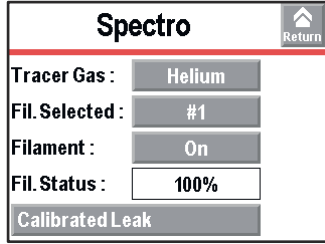

7.5.1 Tracer gas

The tracer gas is the gas searched for during a test. 3 gases are available: ⁴He, ³He and H₂.

From the "Settings" screen, press [Spectro].

Tracer gas ⇒ Select the tracer gas used.

The reject set point is memorized for each configurable tracer gas.

Calibration

The leak detector should be calibrated with a calibrated leak of the same type as the tracer gas used.

Hydrogen test



DANGER

Explosion hazard.
For detecting leaks with 'hydrogen' tracer gas, the operator must use hydrogenated nitrogen (mix of 95 % N₂ and 5 % H₂).

The detector's background is higher in H₂ than ⁴He/³He.

Typical H₂ background, during a test, when the detector is equipped with a blanking flange on the inlet port:

- at switching on:
 - low range ± 1·10⁻⁶ Pa·m³/s (1·10⁻⁵ mbar·l/s)
- after 2 or 3 hours:
 - low range ± 1·10⁻⁷ Pa·m³/s (1·10⁻⁶ mbar·l/s)



For quick access from the control panel, set a function key for [Tracer Gas] (see 7.7.2).

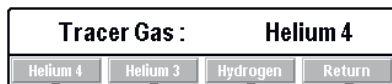

Fig. 37: "Tracer Gas" screen using a function key

7.5.2 Filament parameters

Fil. Selected	Indicates the filament used for the measurement (2 filaments in the analyzer cell).
Filament	Indicates if the filament used is 'on' or 'off' when the detector is switched on.
Fil. status	Indicator of analyzer cell performance. Initial settings: between 90 % and 100 % Normal operation: between 10 % and 100 % Normal wear on some cell components will reduce this value over time but will not reduce the accuracy of the detector's measurements.

7.5.3 Calibrated leak

For further information on calibration and calibrated leaks (see 6.7).

From the "Settings" screen, press [Spectro][Calibrated leak].

Tracer gas ⇒ Set the tracer gas for the calibrated leak used for calibration.

From the "Settings" screen, press [Spectro][Calibrated leak].

Type	⇒ Define the type of calibrated leak used for calibration. <ul style="list-style-type: none"> internal = calibration from the leak detector internal calibrated leak (^4He leak only). external = calibration from an external calibrated leak (^4He, ^3He or H_2 leak). machine = calibration from the internal calibrated leak (^4He leak only) and an external calibrated leak (^4He, ^3He or H_2 leak)
Unit	⇒ Set the calibrated leak unit used for calibration. ⁽¹⁾
Leak Value	⇒ Set the calibrated leak value used for calibration. ⁽¹⁾
Calibration valve	⇒ Define the actual status of the calibration valve. Used to open/close the manual calibration valve, for example. Remember to close the valve again after use. Manual calibration is only for experts.
Loss per Year (%)	⇒ Set the loss rate per year for the calibrated leak used for calibration. ⁽¹⁾
Ref. T. (°C)	⇒ Set the reference temperature for the calibrated leak used for calibration. ⁽¹⁾
Coeff. T. (%/°C)	⇒ Set the temperature coefficient for the calibrated leak used for calibration. ⁽¹⁾
Year	⇒ Set the month and year of calibration for the calibrated leak used for calibration. ⁽¹⁾
Internal T. (°C) or External T. (°C)	'Internal' indicates the temperature at the detector's internal calibrated leak. 'External' indicates the temperature at the detector's external calibrated leak.

(1) Use the information indicated on the calibrated leak used for calibration or on its calibration certificate.

In case of leak replacement, these parameters must be updated. When the parameters are saved, all the data from all the calibrated leaks set is memorised.

7.6 Maintenance Menu

→ From the "Settings" screen, press [Maintenance].

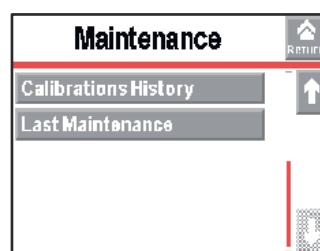
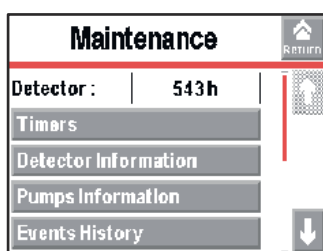

7.6.1 Detector

From the "Settings" screen, press [Maintenance].

Detector	Number of hours that the detector is used.
----------	--

7.6.2 Timers

From the "Settings" screen, press [Maintenance] [Counters].

Detector	Number of hours that the detector is switched on.
Filament 1	Number of hours that filament 1 is on. ⇒ Press [xxx h] [Counter reset] to reset the counter.
Filament 2	Number of hours that filament 2 is on. ⇒ Press [xxx h] [Counter reset] to reset the counter.
Calib. Leak	Indicates the month and year of calibration for the calibrated leak used for calibration.
Cycles	Indicates the number of performed cycles since the last reset / the set cycle number. When the set value is reached, an information message is displayed.
Sec. pump # 1	Indicates the number of hours secondary pump 1 has been operating since the last reset / the set hour number. When the set value is reached, an information message is displayed.



For quick access to the counters from the control panel, set a function key for [Maintenance] (see 7.7.2).

→ To set the set point and reset the cycle counter

From the "Settings" screen, press [Maintenance] [Timers] [xxxx Cy/xxxx Cy].

Cycles	Indicates as a % the number of cycles made in relation to the interval set.
Counter	Indicates the number of cycles made since the latest reset of the counter.
Interval	⇒ Set the value for the counter. When the set value is reached, an information message is displayed.
Reset Counter	⇒ Press [Counter reset] to reset the counter.

→ To set the set point and reset the operating hours counter for each pump's,

From the "Settings" screen, press [Maintenance] [Counters] [xxxx h/xxxx h] for each pump

Pump XXX	Indicates as a % the number of operating hours for the pump XXX in relation to the interval set.
Counter	Indicates the number of operating hours for the pump since the latest reset of the counter.
Interval	⇒ Set the value for the counter. When the set value is reached, an information message is displayed.
Reset Counter	⇒ Press [Counter reset] to reset the counter.

Secondary pump 1: MDP 5011 (ASI 30) - SplitFlow 50 (ASI 35)

7.6.3 Detector Information

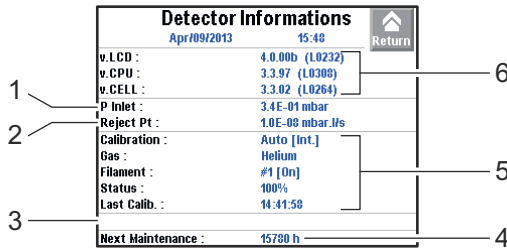

Fig. 38: Detector Information

1	Inlet pressure
2	Reject set point for the test method in progress
3	List of activated functions
4	Primary or secondary pump maintenance
5	Calibration information
6	Detector firmware information



For quick access from the control panel, set a function key for [Infor.] (see 7.7.2).

7.6.4 Pump Information

Secondary Pump #1 The pumping speed of the secondary pump can be configured (see 7.8.12).

From the "Settings" screen, press [Maintenance] [Pump Information] [Sec. Pump #1].

Status	Control of the pump by the detector
Rotation	Pump status: Synchro/Down/Fail/Running/Ram up
Speed (min ⁻¹)	Pump running speed

→ For more information about secondary pump, press [**TMP Information**].

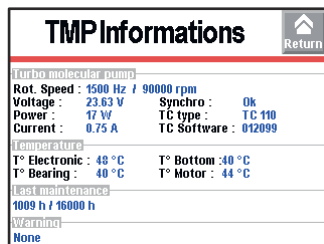

7.6.5 Event history

Event history records the last 30 events. Beyond 30, the oldest recorded event will be replaced by the most recent, and so on.

→ From the "Settings" screen, press **[Maintenance] [Event History]**.

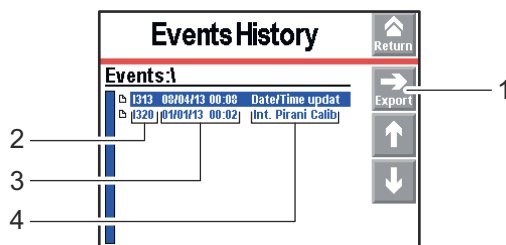

1	Exporting the history in .csv format to the SD card
2	RS code for the event
3	Date - Time of the event
4	Description of the event

Event = Error (Exxx) or Warning (Wxxx) or Event (Ixxx)

List of errors and warnings: see *chapter List of warnings/faults in Maintenance instructions*.

List of events:

Code	Event	Description
I300	Inlet vent	Inlet vent
I301	Stp on pollution	Test stops automatically if measured leak rate pollution > Pollution
I302	RVP ctr reset	Primary pump hour counter reset.
I303	TMP1 ctr reset	Secondary pump 1 hour counter reset
I304	TMP2 ctr reset	Secondary pump 2 hour counter reset (according to detector model)
I306	Fil 1 ctr reset	Filament 1 hour counter reset
I307	Fil 2 ctr reset	Filament 2 hour counter reset
I308	Cycle ctr reset	Cycle counter reset
I310	Autocal restart	Automatic start of a new autocalibration
I313	Date/Time update	Date or time modification
I318	Full param reset	Complete detector parameter reset
I319	Fil change	Filament change (manually or automatically from Maintenance menu)
I320	Int. Pirani Calib.	Automatic internal Pirani gauge calibration
I321	Storage delay	Detector switched off for 15 days (minimum)

7.6.6 Calibration history

The calibration history records the last 20 calibrations made. Beyond 20, the oldest recorded calibration will be replaced by the most recent and so on.

→ From the "Settings" screen, press **[Maintenance] [Calibration History]**.

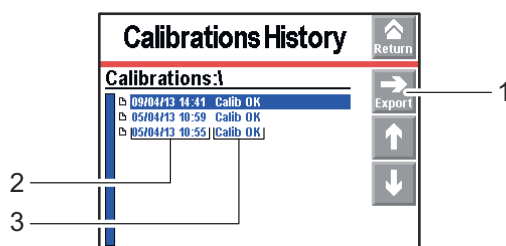

1	Exporting the history in .csv format to the SD card
2	Date - Time of the calibration
3	Calibration result

7.6.7 Last maintenance

This function displays the last three maintenance operations performed on the detector and recorded by the technician having made the intervention.

→ Use the scroll bar to display the last 3 recorded interventions.

From the "Settings" screen, press [Maintenance]. [Last maintenance].	
Date	Date of the maintenance intervention
Nbr hours	Number of hours that the detector has been switched on at the time of the intervention.
Inspected by	Technician who performed the intervention.

7.7 Configuration Menu

→ From the "Settings" screen, press [Config.].

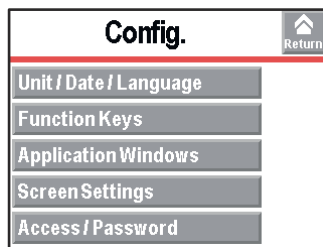

7.7.1 Time - Date - Unit - Language

The update of these parameters is automatically requested when the operator switches the detector on for the first time: after this, the operator can modify them at any time.

From the "Settings" screen, press [Config.] [Unit/Date/Language].	
Unit	⇒ Set the unit to be used. The set points/values set are not automatically converted to the new unit if the unit changes: they must be updated by the operator.
Date	⇒ Set the current date.
Time	⇒ Set the time. The time is not automatically updated when switching from summer time to winter time and vice versa: it must be updated by the operator.
Language	⇒ Set the language.

7.7.2 Function keys

The function keys are used to activate/stop a function or to adjust set points.

Per initial settings, 8 function keys are allocated and distributed over 2 levels: they can be reallocated by the operator.

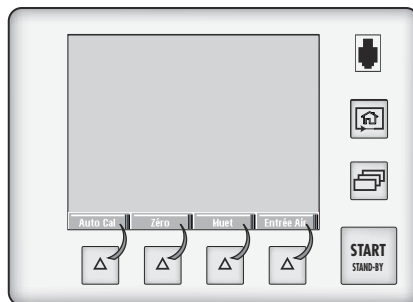

Fig. 39: Function keys

Allocating function keys → From the "Settings" screen, press [Config.] [Function Keys].



Thanks to the function keys, it is possible to give the operator access to a limited number of functions and to use a password to lock unauthorised functions on the "Settings" menu. They are sufficient to manage the detector.

- To allow the operator to use only the [Start/Stand-by] key, do not allocate a function to the function keys and lock the "Settings" menu.
- Up to 4 additional function keys can be added, for a maximum of 12. In this case, a 3rd level is made available to the operator.

Each function key can be allocated to a function chosen by the operator: see the example below.

Example: Allocate the 'Correction' function (1) to the [Mode] function key (2).

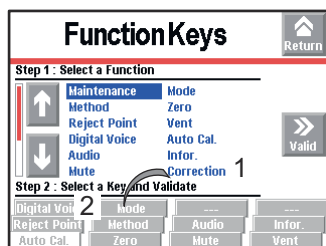

Fig. 40: Allocation objective

→ Select the 'Correction' function (1) using the and .

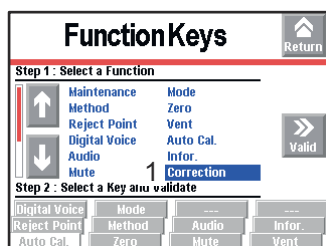

Fig. 41: Selecting the function

→ Select the [Mode] function key (2) by pressing repeatedly (key selected if background is white).

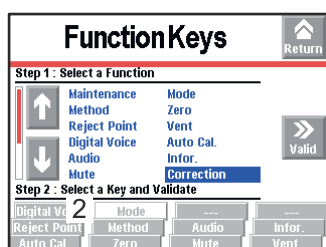

Fig. 42: Selecting the function key

→ Validate the settings (3): the function key (2) is now allocated to the [Correction] function.

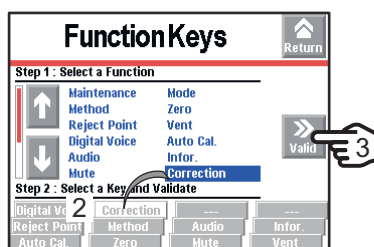



Fig. 43: Result of the allocation

7.7.3 Application screens



➔ From the "Settings" screen, press **[Config.] [Application Windows]**.

By pressing repeatedly on the key , the various screens available appear (see 6.1.3).

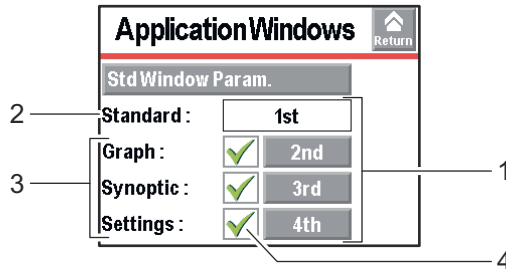
The operator can hide one or more screen or switch the order in which they appear. The "Standard" application screen is always available in 1st position.



1	Order of the displayed screens with the key 
2	"Standard" application screen always displayed
3	Available screens
4	Displaying/hiding the application screen

The screen order can be modified: press the order number (example: **[3rd]**) and use the  and  to choose the new order number then confirm.

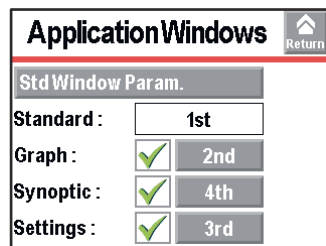



Fig. 44: The "Synoptic" screen order has switched from 3 to 4

When a screen is no longer selected  or if its order has been changed, the general order is automatically updated.

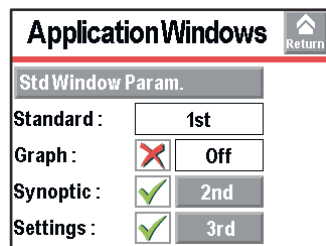

Fig. 45: The "Graph" screen is no longer available

When a screen is selected again, it automatically moves to last place.

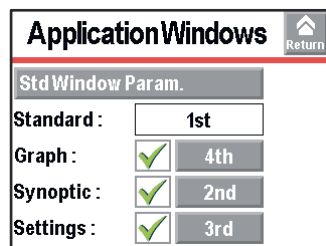

Fig. 46: The "Graph" screen is available again, and in last place.

Setting the "Standard" screen

From the "Settings" screen, press [Config.] [Application screens] [Std. Screen setting].

Std-By value	⇒ Display/Hide the leak rate display in Stand-by mode.
Inlet Pressure	⇒ Display/Hide the inlet pressure display.
Cell pressure.	⇒ Display/Hide the cell pressure display.

From the "Settings" screen, press [Config.] [Application screens] [Std. Std. Screen] [Bar-graph].

Zoom on set point	⇒ Activate zoom to set point. Zoom to set point is used to display on the bargraph the reject set point centred on 2 decades.
Low Decade	⇒ Set the low decade for the bargraph display.
High Decade	⇒ Set the high decade for the bargraph display.

7.7.4 Screen Settings

From the "Settings" screen, press [Config.] [Screen Settings].

Brightness	⇒ Set the brightness.
Contrast	⇒ Set the contrast.
Panel off	⇒ Activate the sleep mode screen. The screen is in sleep mode when the back light goes off (black screen). The device appears to be off, but this is not the case! Simply touching the screen reactivates the display.
Paging Func.	⇒ Activate the Paging function. When a RC 500 WL remote control (accessory) is used, the 'Paging' function makes it possible to easily find the remote if it is located within its field of use with the detector. When the function is activated, the remote emits a sound signal so it can be located. To stop the sound signal, deactivate the Paging function.

→ Press [Reset Panel Param.] to reset the control panel parameters.

7.7.5 Access - Password

→ From the "Settings" screen, press [Config.] [Access/Password].

→ Enter the password ('5555' by default) and validate.

Menu access

The operator can lock access to one or more menus on the "Settings" screen. To access a locked menu, the operator will be asked to provide the password.

→ Lock a menu by pressing .

→ Unlock a menu by pressing .

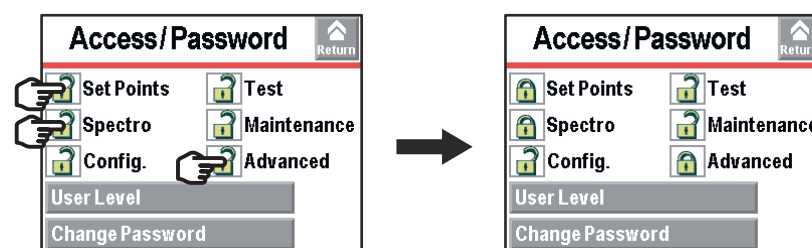

Fig. 47: Example: Locking the Set Points, Spectro and Advanced menus

On the "Settings" screen, the locked menus are indicated by .

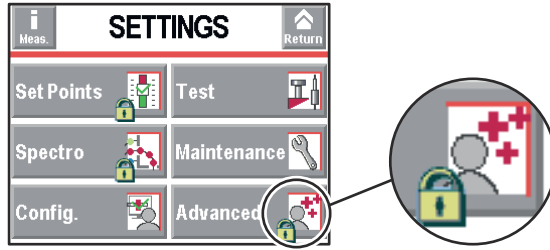

Fig. 48: Locked menus



- Change password**
- From the "Settings" screen, press **[Config.] [Access/Password]**.
 - Enter the password ('5555' by default) and validate.
 - Press **[Change Password]**.
 - Enter the new password and validate.



The password is saved in the control panel. If the password is forgotten, it can be found using the RS-232: see the RS-232 operating instructions.

- User level**
- From the "Settings" screen, press **[Config.] [Access/Password] [User level]**.
- 3 user levels can be used to restrict the display and operator access to settings and functions:
- restricted access,
 - medium access,
 - full access.

Limits with Restricted access

- Key  invalid: no settings can be made without password.
- Pictogram  invalid.
- Function keys hidden.
- Inlet pressure and cell pressure hidden.
- Key  invalid: launch of a test via a communication interface only.
- Measured leak rate and reject set point displayed only in test.

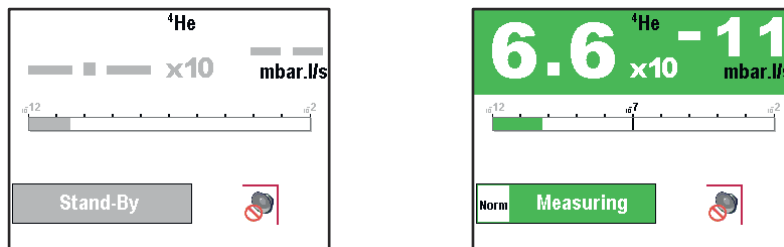



Fig. 49: Displays with Restricted access



With Medium or Restricted access, the operator can temporarily access the 6 menus on the "Settings" screen to set parameters.

- Press and hold the key  until the "Settings" screen is displayed with all the locked menus.
- Press the desired menu.
- Enter the current password ('5555' by default) and validate.
- Carry out the desired parameter settings.

Limits with Medium access

- Key  invalid: no settings can be made without password.
- 2 function keys available: **[Basic Param.]** and **[Info.]**.

Basic Param		Return
Hard Vac. Set Points :	1.00E-07 mbar.l/s	
Sniffer Set Points :	1.00E-06 mbar.l/s	
Method :	Hard Vacuum	
Mode :	Normal	
Gas :	Helium 4	
P Inlet :	2.2E-03 mbar	

Detector Information		Return
Jan/02/2013 19:18		
v.LCD :	4.0.00d (L0343)	
v.CPU :	3.3.99 (L0309)	
v.CELL :	3.3.02 (L0264)	
P Inlet :	3.5E-03 mbar	
Reject Pt :	1.0E-07 mbar.l/s	
Calibration :	Auto [Int.]	
Gas :	Helium 4	
Filament :	#1 [On]	
Status :	100%	
Last Calib. :	18:53:17	
Next Maintenance :	14990 h	

- Function keys hidden.
- Inlet pressure and cell pressure hidden.
- Key  valid.
- Measured leak rate and reject set point displayed only in test.

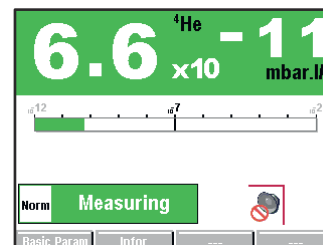
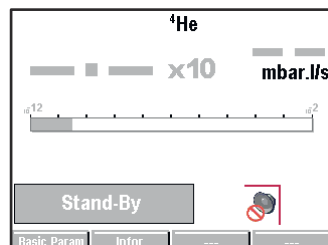



Fig. 50: Displays with Medium access



With Medium or Restricted access, the operator can temporarily access the 6 menus on the "Settings" screen to set parameters.

- ➔ Press and hold the key  until the "Settings" screen is displayed with all the locked menus.
- ➔ Press the desired menu.
- ➔ Enter the current password ('5555' by default) and validate.
- ➔ Carry out the desired parameter settings.

Limits with Full access

- No limit.

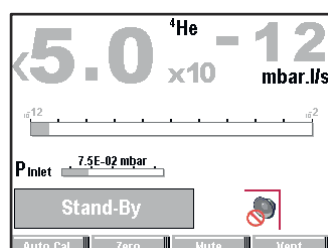



Fig. 51: Displays with Full access

Operator with Restricted or Medium access changing the access level.

- ➔ Press  until the "Settings" screen is displayed with all the locked menus.
- ➔ Press **[Config.]**.
- ➔ Enter the current password ('5555' by default) and validate.
- ➔ Press **[Access/Password]**.

- Enter the current password ('5555' by default) and validate.
- Press **[User Level]**.
- Change the access level: see below the limits for each level.

Operator with Full access changing the access level.

- From the "Settings" screen, press **[Config.] [Access/Password]**.
- Enter the current password ('5555' by default) and validate.
- Press **[User Level]**.
- Change the access level: see below the limits for each level.

7.8 Advanced Menu

The Advanced menu is reserved for leak detection experts and/or for setting a particular product.

- From the "Settings" screen, press **[Advanced]**.

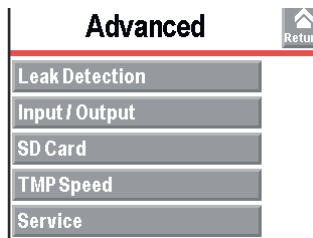

7.8.1 Leak Detection Menu

- From the "Settings" screen, press **[Advanced][Leak Detection]**.

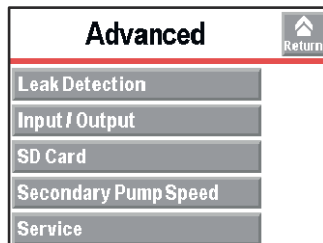

7.8.2 Leak Detection: Start-up timer

The start-up timer prevents the leak detector from being used for a pre-determined duration after it has been switched on. This means measurements cannot be made until the leak detector is thermally stabilized, or while traces of tracer gas remain in the detector.

From the "Settings" screen, press [Advanced] [Leak Detection].

Start-up timer	⇒ Set the start-up timer.
----------------	---------------------------

7.8.3 Leak detection: Detector pressure gauge

The gauge is connected directly to the electronic module.
 Allows the leak detector to be controlled by a pressure gauge.

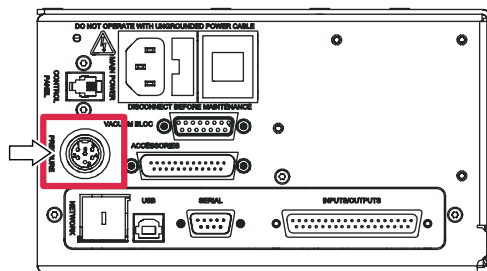

Setting

From the "Settings" screen, press [Advanced] [Leak Detection] [Detector pressure gauge].

Gauge	No automatic recognition of the gauge upon connection. ⇒ Select the type of external gauge.
Full scale (mbar)	Only for a linear gauge ⇒ Set the operating range for the gauge: value indicated on the gauge.

Possible gauges

- The gauge is at the customer's expense.

		Type of gauge set	Gauge model
Linear gauges	Capacitive	Linear	CMRxxx
	Piezo	Linear	APRxxx
Logarithmic gauges	Pirani	TPR/PCR	TPRxxx
	Pirani capacitive	TPR/PCR	PCRxxx

7.8.4 Leak Detection: External gauge

Allows the leak detector to be controlled by an external gauge and/or recover the pressure of the detector.

The gauge is connected to the 37-pin I/O connector on the electronic module with a specific cable available as an accessory (see 10).

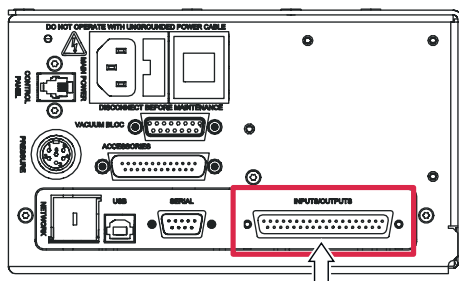

Preliminary conditions

Detector equipped with the 37 pin I/O interface (see 10).

Configuration

- Use of an external gauge to control the detector:
 - If the external gauge is to control the detector: configuration of the inlet pressure source used = 'external'.

From the "Settings" screen, press [Advanced] [Leak Detection] [External Gauge].

Gauge	⇒ Automatic recognition of the type of external gauge connected.
Ext. p (mbar)	Indicates the pressure measured by the external gauge.
Inlet Press. source	⇒ Set the gauge controlling the detector: <ul style="list-style-type: none"> • 'internal': pressure gauge of the detector connected directly to the electronic module • 'external': external gauge of the customer's installation connected to the electronic module with the 37-pin I/O connector 'Internal' gauge by default.
Full scale (mbar)	Only for a linear gauge ⇒ Set the operating range for the gauge: value indicated on the gauge.

- Use of the external gauge to recover the pressure of the detector:
 - Allocate an analogue output of the 37-pin I/O connector to external pressure: see the operating instructions for the 37-pin I/O interface.

- Possible gauges**
- The gauge and the cable are at the customer's expense.
 - 2 cables available as accessories (see 10).

		Type of gauge detected by the detector	Gauge model
Linear gauges	Capacitive	Linear	CMRxxx
	Piezo	Linear	APRxxx
Logarithmic gauges	Pirani	TPR/PCR	TPRxxx
	Pirani capacitive	TPR/PCR	PCRxxx



The cables (accessories) are only prepared for the connection of a gauge. The user can modify the wiring to control other I/Os (wiring modification at the customer's expense).

7.8.5 Leak detection: Analyzer cell

From the "Settings" screen, press [Advanced] [Leak Detection] [Analyzer Cell].

Fil. Selected	Indicates the filament used for the measurement (2 filaments in the analyzer cell).
Filament	Indicates if the filament used is 'on' or 'off' when the detector is switched on.
<ul style="list-style-type: none"> - Triode pressure - Elec.Zero - Target value - Acc. voltage (V) - Emission (mA) - Coeff. Sens. 	Parameters for manual calibration. This type of calibration is reserved for service centres and leak detection experts only.
Calib. valve	⇒ Define the actual status of the calibration valve. Used to open/close manually the calibration valve, for example. Remember to close the valve again after use. Manual calibration is only for experts.
Internal T (°C) or External T (°C)	'Internal' indicates the temperature at the detector's internal calibrated leak. 'External' indicates the temperature at the detector's external calibrated leak.



Do not switch off the filament except for carrying out manual calibration. It is not necessary to switch the filament off in Stand-by mode to save it.

- The leak detector switches automatically from one filament to the other if the selected filament currently being used becomes defective.
- When switched on, the leak detector uses the filament that was selected when it was shut down.

7.8.6 Leak Detection: Calibration

For further information on calibration and calibrated leaks (see 6.7).



NOTICE

Detector calibration

For optimum use of the detector, 20 minutes after switching on, **the detector must be calibrated.** A calibration must also be performed:

- at least once a day
- to optimise the measurement reliability for high sensitivity tests
- if it is uncertain whether the detector is working properly
- during intense and continuous operation: start an internal calibration at the beginning of each work session (e.g. work in shifts, every 8 hours).

Calibration makes it possible to verify that the detector is properly adjusted to detect the selected tracer gas and display the correct leak rate value.

From the "Settings" screen, press [Advanced] [Leak Detection] [Calibration].

Calibration	⇒ Select the type of calibration. See details below.
Calib. Control	⇒ Activate the calibration checking and set the frequency. See details below.

- Detector without Calibration

- The detector can be calibrated with an external calibrated leak.
- By default, calibration is set to 'Operator' and 'External' leak is selected.
- Detector with Calibration
 - By default, calibration is set to 'Operator' and 'Internal' leak is selected.

Calibration = 'operator' Calibration started by the operator.

→ Press the [AUTOCAL].

If calibration has not been started 20 minutes after the product is powered up, a message is displayed inviting the user to calibrate it.

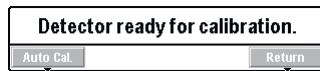

Fig. 52: Leak detector ready for calibration

Calibration = 'manual' Calibration starts manually.

Operation reserved for service centres and experts only.

It is also possible to calibrate the leak detector using an external leak (see 6.7.4).

"Calibration control" setting

Calibration control saves the operator time because the calibration control is quicker than the full calibration.

If calibration = 'operator', the calibration control function performs a control of the calibration according to the parameters set.

The calibration control is deactivated if calibration = 'manual'.

The calibration control is carried out with the leak detector's reference calibrated leak.

The leak detector compares the measured leak rate of the reference calibrated leak with the set leak rate for this same leak:

- If the ratio is within the limits allowed, the leak detector is properly calibrated.
- If the ratio is outside those limits, a message appears suggesting that a full calibration of the leak detector be started.

Checking	⇒ Select the type of calibration (activated if 'operator' has been set).
Frequency	⇒ Set the set points (cycles and times) for triggering the calibration control. The first set point reached will trigger the control.



To launch the function from the control panel, set a function key to [Check Cal].

At any time, the operator can start a leak detector calibration control: detector in Stand-by mode, press the [AUTOCAL] function key twice within 5 seconds.

- Calibration control with external leak: the set test mode must be coherent with the detector connection.
 - mode = identical to the port used for the connection of the detector (example: connection on the Normal port - > selected 'Normal' mode) (see 5.2).

7.8.7 Leak detection: Dynamic calibration

This function allows predictive adjustment of the leak rate for repetitive tests where the test time has to be optimised.

The adjustment is made via the RS-232 or logic inputs.



NOTICE

This function provides an adjustment and should not be confused with the correction coefficient. This coefficient complements the correction coefficient.

From the "Settings" screen, press [Advanced] [Leak Detection] [Dynamic calibration].

Active	⇒ Activate the dynamic calibration
Value	⇒ Set the target value to reach (leak rate value of the installation to calibrate)
Coefficient	Coefficient value calculated during dynamic calibration (Coefficient applied if dynamic calibration is activated)

- Preliminary conditions**
- Perform leak detector autocalibration.
 - Activate the correction factor (see 7.4.2) and set it.
 - Activate the dynamic calibration.
 - Set the target value.
 - Allocate the logic inputs (see 37-pin I/O Operating instructions) or connect the RS-232 link.

	Logic input	RS-232 command
Start/Stop dynamic calibration coefficient calculation	Dynamic cal.	Start: =CDC Stop: =CDS
Start/Stop Test	HV test	Start: =CYE Stop: =CYD
Start/Stop Memo function	He memo	Start: =MEF Stop: =MER

- Setting procedure for one test**
- Implement the preliminary conditions.
 - Activate the dynamic calibration coefficient calculation.
 - Start a test.
 - Activate the Memo function (logic input or RS). The new coefficient is automatically calculated and saved.

The calculated coefficient corresponds to the following ratio:

$$\text{coefficient} = \frac{\text{target value}}{\text{value of the leak rate displayed to adjust}}$$

The calculated coefficient must be between 0.5 and 3 inclusive. If not, an error message is displayed.

- Stop the test and deactivate the Memo function (logic input or RS).
- Stop the dynamic calibration coefficient calculation.

Example:

Target value = $1.0 \cdot 10^{-7}$

Value of the leak rate displayed to adjust: $5.0 \cdot 10^{-8}$

$$\text{coefficient} = \frac{1.0 \cdot 10^{-7}}{5.0 \cdot 10^{-8}} = 2$$

As 2 is between 0.5 and 3, the coefficient is correct.

- Setting procedure for several tests**
- Several tests can be run to calculate the dynamic calibration coefficient. This allows the coefficient value to be fine-tuned.

- Implement the preliminary conditions.
- Activate the dynamic calibration coefficient calculation.
- Run the 1st test.
- Activate the Memo function (logic input or RS). The new coefficient is automatically calculated and saved.

The 1st coefficient calculated for the 1st test corresponds to the following ratio:

$$\text{1st coefficient (Coef 1)} = \frac{\text{target value}}{\text{value of the leak rate of the 1st test}}$$

The calculated coefficient must be between 0.5 and 3 inclusive. If not, an error message is displayed.

- Stop the test and deactivate the Memo function (logic input or RS).
- Repeat the last 3 operations n number of times:
 - Run a test
 - Activate the Memo function
 - Stop the test and deactivate the Memo function

The calculated and memorised coefficient is readjusted after each test, as in:

$$\text{coefficient} = \frac{\text{Coef 1} + \text{Coef 2} + \text{etc.} + \text{Coef n}}{n}$$

→ Stop the dynamic calibration coefficient calculation.



NOTICE

As long as the calculation of the calibration coefficient is not stopped, the coefficient will be adjusted after each test.

7.8.8 Signal processing

This function is used to modify signal processing to improve:

- either the stability of the signal with processing of the stable signal,
- or the reactivity of the signal with processing of the fast signal.

From the "Settings" screen, press [Advanced] [Leak Detection] [Signal processing].

Stable	Slow signal processing improving the stability of the tracer gas signal.
Fast	Fast signal processing improving the reactivity of the tracer gas signal.



Stable signal processing is recommended in most cases.
Fast signal processing is useful for an application with a very short cycle time, e.g. dynamic measurements with automated leak detection systems

7.8.9 Input/Output menu

→ From the "Settings" screen, press [Advanced] [Input/Output].

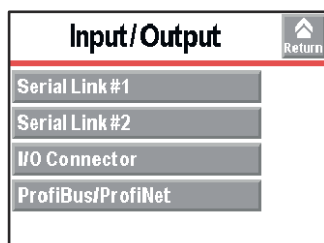

7.8.10 Input/Output: Serial Link 1 and Serial Link 2

From the "Settings" screen, press [Advanced] [Input/Output], then [Serial Link 1] or [Serial Link 2].

Type	⇒ Set the type of serial link: see table below.
Parameters	⇒ Set the serial link mode: see detail below.

The operator must allocate the 2 serial links (1 and 2) according to their use.

Use	Possible allocation		Type to select
	Serial Link 1	Serial Link 2	
RS-232 ⁽¹⁾	yes	no	Serial
USB ⁽¹⁾	yes	yes	USB
Ethernet ⁽²⁾	no	yes	Network
Profibus ⁽³⁾	no	yes	Anybus
Profinet ⁽³⁾	no	yes	Anybus

⁽¹⁾ With all 37-pin I/O boards (option)

⁽²⁾ With I/O Ethernet board (option)

⁽³⁾ Option

Parameters → From the "Settings" screen, press **[Advanced] [Input/Output] [Serial Link 1]** or **[Serial Link 2] [Parameters]**.

Mode	Description	Use ⁽¹⁾	
		RS-232	USB / Ethernet
Basic	Continuous acquisition of data sent to the hyperterminal according to a defined time duration. At any time, a command can be sent to the leak detector. Recommended mode during leak detector test procedure setting operations.	x	x
Spreadsheet	Variation of the Basic mode. Continuous data acquisition, formatted in a spreadsheet such as Excel Microsoft® Office or other similar software. Recommended mode for drawing graphs.	x	x
Advanced	Full control of the detector by a supervisor. The detector sends information at the supervisor's request. 5 V power supply available. Recommended mode for automatic systems.	x	x
Export Data	Export, via a PC, of "tickets" issued by the detector after: <ul style="list-style-type: none"> • Calibration with an internal/external calibrated leak, • Calibration control with an internal leak, • A test. Serial links 1 and 2 must not be in "Export Data" mode at the same time.	x	x
RC 500 WL	Use of a wireless remote control (model RC 500 WL). ⁽¹⁾	x	-
RC 500	Use of a wired remote control (model RC 500). ⁽¹⁾	x	-
HLT 5xx	Protocol for compatibility with the HLT 5xx detector protocol. List of orders for the protocol compatible with ASM 340/ASI 35 (See RS-232 Operating instructions).	x	x
HLT 2xx	Protocol for compatibility with the HLT 2xx detector protocol. List of orders for the protocol compatible with ASM 340/ASI 35 (See RS-232 Operating instructions).	x	x
Ext. module	Full control of the detector by a supervisor. The detector sends information at the supervisor's request. 24 V power supply available. A 24 V power supply is required for using an external module (example: profibus).	x	-

(1) See Standard Remote Control Operating instructions for more details.

Profibus/Profinet: Further information on the screen **[Serial Link 1]** or **[Serial Link 2]** (see **Profibus/Profinet Operating instructions** (see 1.1.1)).

7.8.11 Input/Output: I/O connector

→ From the "Settings" screen, press **[Advanced] [Input/Output] [I/O Connector]**.

The detector is equipped:

- either with a 15-pin I/O interface (see **15-pin I/O board Operating instructions**) if Profibus/Profinet option available on the detector,
- or with a 37-pin I/O interface (see **37-pin I/O board Operating instructions**).

7.8.12 Secondary pump speed

From the "Settings" screen, press [Advanced] [Secondary pump speed] .	
Actual (rpm/Hz)	Current pumping speed of the turbomolecular pump.
Target (rpm/Hz)	⇒ Set the pumping speed of the turbomolecular pump: <ul style="list-style-type: none"> – 1500 Hz/90,000 min⁻¹: standard configuration for use of the detector within the standard temperature range – 1000 Hz/60,000 min⁻¹: configuration recommended if the detector is used in a hotter atmosphere (a few degrees above the maximum use temperature). At this speed, the performances of the detector are variable (see 11.2).

7.8.13 SD Card menu

From the "Settings" screen, press [Advanced] [SD card].

Load Detector Param.	⇒ Load the saved parameters onto the SD card.
Save Detector Param.	⇒ Save the leak detector parameters to the SD card.
View * BMP	⇒ View the saved ".bmp" files.



Creating a library of the configurations for each application is recommended if the detector is used for more than one application. Any SD card on the market can be used except cards with High Capacity technology, regardless of the memory size. Before use, make sure that the SD card is not locked (message "SD card not detected" displayed).

7.8.14 Service

Access to the Service menu is password protected. Reserved for the Service Centres.

8 Maintenance / replacement



NOTICE

Disclaimer of liability

Pfeiffer Vacuum accepts no liability for personal injury or material damage, losses or operating malfunctions due to improperly performed maintenance. The liability and warranty entitlement expires.

8.1 Maintenance intervals and responsibilities

The detector maintenance operations are described in the ***Maintenance instructions*** for the detector.

The manual specifies:

- maintenance intervals
- maintenance instructions
- shutting the product down
- tools and spare parts.

The maintenance instructions is available on www.pfeiffer-vacuum.com and on the ***CDRom of the detector's operating instructions***.

9 Service

Pfeiffer Vacuum offers first-class customer service!

- On-Site maintenance for many products
- Overhaul/repair at the nearby Service Location
- Fast replacement with refurbished exchange products in mint condition
- Advice on the most cost-efficient and quickest solution

Detailed information, addresses and forms at: www.pfeiffer-vacuum.com (Service).

Overhaul and repair at the Pfeiffer Vacuum Service Center

The following general recommendations will ensure a fast, smooth servicing process:

- Fill out the "Service Request/Product Return" form and send it to your local Pfeiffer Vacuum Service contact.
- Include the confirmation on the service request from Pfeiffer Vacuum with your shipment.
- Fill out the declaration of contamination and include it in the shipment (mandatory!). The Declaration of contamination is valid for any product/device including a part exposed to vacuum.
- Dismantle all accessories and keep them.
- Close all the flange opening ports by using the original protective covers or metallic airtight blank flanges for contaminated devices.
- If possible, send the pump or unit in its original packaging.

Sending contaminated pumps or devices

No devices will be accepted if they are contaminated with micro-biological, explosive, or radioactive substances. "Hazardous substances" are substances and compounds in accordance with the hazardous goods regulations (current version).

- Neutralize the pump by flushing it with nitrogen or dry air.
- Close all openings airtight.
- Seal the pump or device in suitable protective film.
- Return the pump/device only in a suitable and sturdy transport container and send it in while following applicable transport conditions.

Pump or device returned without declaration of contamination form fully completed and/or not secured in suitable packaging will be decontaminated and/or returned at the shipper's expense.

Exchange or repair

The factory operating parameters are always pre-set with exchange or repaired devices. If you use specific parameters for your application, you have to set these again.

Service orders

All service orders are carried out exclusively according to our general terms and conditions for the repair and maintenance, available on our website.

10 Accessories

Description	Part number
Standard Sniffer Probe	See catalogue Pfeiffer Vacuum
Sniffer probe extension (10 m)	090216
Smart Sniffer Probe (3 m)	BG 449 207 -T
Smart Sniffer Probe (5 m)	BG 449 208 -T
Smart Sniffer Probe (10 m)	BG 449 209 -T
Helium 4 calibrated leak	See catalogue Pfeiffer Vacuum
Adaptor for external calibrated leak DN 25 ISO-KF	110716
Spray gun (Elite)	109951
Spray gun (Standard)	112535
ASI 20 MD type module	123352
2xxx type module	123353
3xxx type module	123354
20 µm inlet filter, DN 25/25 ISO-KF	105841
5 µm inlet filter, DN 25/25 ISO-KF	105844
CMR / APR / TPR / PCR xxx gauge	See catalogue Pfeiffer Vacuum
Cable for CMR / APR / TPR / PCR xxx gauge ⁽¹⁾	See catalogue Pfeiffer Vacuum
3 m cable for CMR / APR / TPR / PCR xxx gauge ⁽²⁾	A333746
10 m cable for CMR / APR / TPR / PCR xxx gauge ⁽²⁾	A333747
Industrial control panel ⁽³⁾	122447S
1.8 m cable for industrial control panel	114435
5 m cable for industrial control panel	A458735
10 m cable for industrial control panel	110881
1.5 m cables between electronic module and detection module	123287
3.5 m cables between electronic module and detection module	123288
5 m cables between electronic module and detection module	123289
10 m cables between electronic module and detection module	123290
Sniffing kit	123529
Internal calibration kit	123530

⁽¹⁾ Cable for connection of the external gauge (see 7.8.4).

⁽²⁾ Cable for connection of the detector pressure gauge (see 7.8.3).

⁽³⁾ Panel delivered without cable: to be ordered separately

11 Technical data and dimensions

11.1 General

Databases of the leak detectors' technical characteristics Pfeiffer Vacuum:

- Technical characteristics according to:
 - AVS 2.3: Procedure for calibrating gas analyzers of the mass spectrometer type.
 - EN 1518: Non-destructive testing. Leak testing. Characterization of mass spectrometer leak detectors.
 - ISO 3530: Methods of calibrating leak-detectors of the mass-spectrometer-type used in the field of vacuum technology.
- Zero function or background suppression activated, in standard conditions (20 °C, 5 ppm ⁴He ambient, degassed detector).
- Primary pump connected to the detector: RVP 2005

11.2 Technical data

Parameters	ASI 35
Start-up time (20°C) without calibration	≈ 3 mn
Max. power consumption	300 W
Operating temperature	10 - 45 °C
Detectable gases	⁴ He, ³ He, H ₂
Minimum detectable leak rate for helium	See tables below
Interface	RS-232, USB, Ethernet, Profibus, Profinet
Power supply	90-240 V 50/60 Hz

Minimum detectable leak rate for helium ⁽²⁾ : hard vacuum test				
Secondary pump speed	Detection module connection	Minimum detectable leak rate for ⁴ He Pa m ³ /s (mbar l/s)	Crossover pressure Pa (mbar)	He flow rate (l/s)
1500 Hz	Gross Leak mode port	3.5·10 ⁻⁹ (3.5·10 ⁻⁸)	1800 (18)	- ⁽¹⁾
	Normal mode port	1·10 ⁻¹¹ (1·10 ⁻¹⁰)	100 (1)	1.8
	High Sensitivity mode port	< 5·10 ⁻¹³ (< 5·10 ⁻¹²)	20 (0.2)	6
1000 Hz	Gross Leak mode port	5·10 ⁻¹⁰ - 5·10 ⁻⁹	1800 (18)	- ⁽¹⁾
	Normal mode port	6·10 ⁻¹² - 6·10 ⁻¹¹	350 (3.5)	1.5
	High Sensitivity mode port	< 5·10 ⁻¹³ (< 5·10 ⁻¹²)	10 (0.1)	5

Minimum detectable leak rate for helium ⁽²⁾ : sniffing test (option/accessory)		
Secondary pump speed	Minimum detectable leak rate for ⁴ He with Smart probe Pa m ³ /s (mbar l/s)	Maximum flow RVP 2005 (sccm)
1500 Hz	1.5·10 ⁻⁹ - 1.5·10 ⁻⁸	800
1000 Hz	1·10 ⁻⁹ - 1·10 ⁻⁸	300

⁽¹⁾ Depending on the primary pump used

⁽²⁾ Minimum detectable leak rate measured in the following conditions:

- stable operating temperatures within the authorised range,
- product switched on for at least 2 hours,
- RVP 2005 as primary pumping.

Environmental conditions	
Storage temperature	- 25 °C to + 70 °C
Maximum air humidity	80 % up to 31 °C, descending to 50 % on a straight-line basis up to 45 °C

Weight	
Detection module	14.5 kg
Electronic module	4.5 kg
Industrial control panel (option/accessory)	1.3 kg

11.3 Dimensions

Detection module

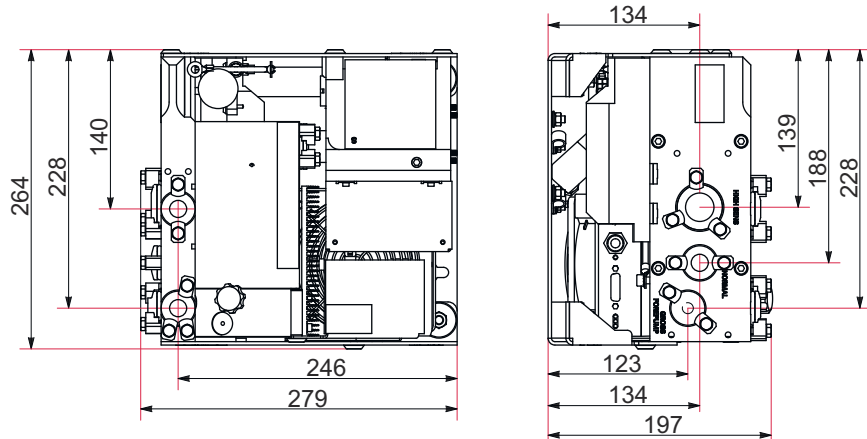

Electronic module

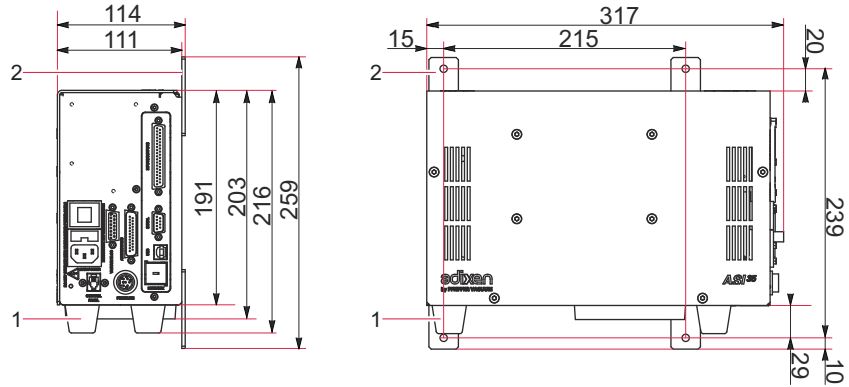

1 Removable feet (see 5.1.2)

2 Removable fixing lugs (not fixed, delivered with the detector) (see 5.1.2)

Industrial control panel (option or accessory)

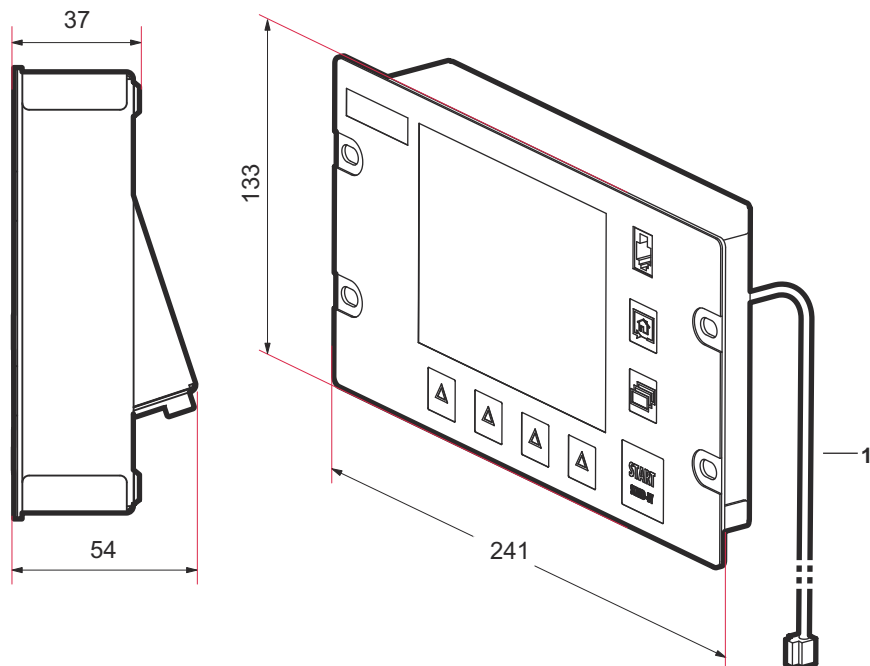

1 The cable is not delivered with the industrial control panel.

12 Appendix

12.1 ASI 20 MD / ASI 30 / ASI 35 specific features

ASI 20 MD	ASI 30	ASI 35
Electronic module		
1 module low voltage and 1 module high voltage	1 multi-voltage module	
Front side with 1 rack 19" format	A plate used to mount the electronic module in a ½ rack format, is delivered with the detector.	
3 connectors to control fixed and not modifiable I/O	1 37-pin D-Sub connector to manage the I/O: – configuration of the 37-pin D-Sub connector I/Os – use of an 'interface extension kit' to provide the facilities of 3 ASI 20 MD connectors	1 37-pin D-Sub connector to manage the I/O: – configuration of the 37-pin D-Sub connector I/Os – use of one of the 3 ASI20MD/2xxx/3xxx type modules to provide the facilities of the 3 ASI 20 MD connectors or other product.
	2 connectors to configure: – either for the control panel – or for the remote control	1 connector for the control panel
Detection module		
4 attachment points on the bracket or the sole of the module: different between-centres dimensions for each product		
Flexible size for integration – rotation of the detection module and the analyzer cell – position of the analyzer cell and the calibrated leak	Compact, non-modular module	
Calibrated leak as standard	Calibrated leak as an option/accessory	
Industrial control panel		
Standard supply	Supply as an option or accessory	
1 rack 19" 3U format	½ rack format – The drawing of a plate used to mount the industrial control panel in a 1 rack format is available in the operating instructions CDRom (manufacture of this plate is at the customer's expense).	
Control panel with loudspeaker	No loudspeaker: an external loudspeaker, headphone or buzzer can be connected (at the customer's expense)	
Specific control panel	Identical industrial control panel for ASI 30/35.	
Maximum cross over thresholds on test		
2 test modes: Gross Leak and Normal		3 test modes: Gross Leak, Normal and High Sensitivity
– Gross Leak Mode: 20 hPa – Normal Mode: 2 hPa	– Gross Leak Mode: 40 hPa – Normal Mode: 4 hPa	Variable thresholds depending on the frequency of the secondary pump (see 5.2).
Accessory / Option		
Specific sniffer kit for ASI 20 MD/ASI 30 ⁽¹⁾		Specific sniffer kit for ASI 35 ⁽¹⁾
RVP 2005 IS ⁽¹⁾		Standard primary pump ⁽¹⁾
Measurement kit with PI3C gauge ⁽¹⁾	No measurement kit TPR/PCRxxx gauge ⁽¹⁾ Compatibility with PI3C gauge 1 ASI20MD type I/O module ⁽¹⁾	No measurement kit CMR/APR/TPR/PCRxxx gauge ⁽¹⁾ No compatibility with PI3C gauge 3 ASI20MD/2xxx/3xxx type I/O modules ⁽¹⁾
No Bluetooth	Bluetooth ⁽¹⁾⁽²⁾	No Bluetooth
No 37-pin I/O board	37-pin I/O board with/without Wi-Fi or Ethernet ⁽¹⁾⁽²⁾	37-pin I/O board with/without Ethernet ⁽²⁾
No Profibus	Profibus ⁽¹⁾⁽²⁾	Profibus ⁽²⁾
No Profinet	No Profinet	Profinet ⁽²⁾

⁽¹⁾ Accessory

⁽²⁾ Option



Declaration of conformity

We hereby declare that the product cited below satisfies all relevant provisions according to the following **EC directives**:

- **Machinery 2006/42/EC (Annex II, no. 1 A)**
- **Electromagnetic Compatibility 2014/30/EU**
- **Restriction of the use of certain Hazardous Substances 2011/65/EU**
- **Waste of Electrical and Electronic Equipment 2012/19/EEC**

The technical file is drawn up by Mr Arnaud FAVRE, Pfeiffer Vacuum SAS, [simplified joint stock company], 98, avenue de Brogny · B.P. 2069, 74009 Annecy cedex.

ASI 35

P/n Sxxx0x0xMM9A (x being an option of the commercial configurator)

Harmonised standards and national standards and specifications which have been applied:

NF Standards EN-61000-6-2: 2005

Standards NF ENV-50204: 1996

NF Standards EN-61000-6-4: 2007

NF Standards EN-60204-1: 2006

Signatures:

Pfeiffer Vacuum SAS
98, avenue de Brogny
B.P. 2069
74009 Annecy cedex
France

(M. Taberlet)
President

(M. Favre)
Research and Development Director

28.06.2017

VACUUM SOLUTIONS FROM A SINGLE SOURCE

Pfeiffer Vacuum stands for innovative and custom vacuum solutions worldwide, technological perfection, competent advice and reliable service.

COMPLETE RANGE OF PRODUCTS

From a single component to complex systems:

We are the only supplier of vacuum technology that provides a complete product portfolio.

COMPETENCE IN THEORY AND PRACTICE

Benefit from our know-how and our portfolio of training opportunities!

We support you with your plant layout and provide first-class on-site service worldwide.

Ed 01 - Date 2019/05 - P/N: 127801OEN



Are you looking for a
perfect vacuum solution?
Please contact us:

Pfeiffer Vacuum GmbH
Headquarters • Germany
T +49 6441 802-0
info@pfeiffer-vacuum.de

www.pfeiffer-vacuum.com

PFEIFFER  **VACUUM**